

# Ancon<sup>®</sup>

## Wall Ties & Restraint Fixings

for the Construction Industry

# We are one team. We are Leviat.

Leviat is the new name of CRH's construction accessories companies worldwide.



Under the Leviat brand, we have united the expertise, skills and resources of Ancon and its sister companies to create a world leader in fixing, connecting and anchoring technology.

The products you know and trust will remain an integral part of Leviat's comprehensive brand and product portfolio. As Leviat, we can offer you an extended range of specialist products and services, greater technical expertise, a larger and more agile

supply chain and better, faster innovation.

By bringing together CRH's construction accessories family as one global organisation, we are better equipped to meet the needs of our customers, and the demands of construction projects, of any scale, anywhere in the world.

This is an exciting change. Join us on our journey.

Read more about Leviat at [Leviat.com](http://Leviat.com)

Our product brands include:

**Ancon**



**HALFEN**

**HELIFIX**

**ISEDIO**

**PLAKA**

Imagine. Model. Make.

[Leviat.com](http://Leviat.com)

# Product Approvals & Certifications

From the 1st January 2021 there are a number of changes to the product approvals on our products due to changes to product marking.

The table below highlights the relevant markings for each of our Wall Tie & Restraint Fixings range. Full DoPs can be downloaded from our website at: [www.ancon.co.uk/approvals](http://www.ancon.co.uk/approvals)

## UKCA Marking

The UKCA (UK Conformity Assessed) marking is the new UK product marking that will be used for goods being placed on the market in Great Britain.

## CE UKNI Marking

The UKNI marking is a new conformity marking for products placed on the market in Northern Ireland which will be used on products that have undergone mandatory third-party conformity assessment by a body based in the UK.

## CE Marking

For products used in Europe the existing CE mark will still remain. Our DoPs have been updated, please visit [www.ancon.co.uk/approvals](http://www.ancon.co.uk/approvals) for the latest version for the products highlighted below.

Product	UKCA	CE UKNI	CE	NBS Plus	CAD Details	BIM
HRT4	✓	-	✓	✓	✓	✓
RT2	✓	-	✓	✓	✓	✓
ST1	✓	-	✓	✓	✓	✓
Two-Part Tie	✓	✓	-	✓	✓	✓
SDB 125-300mm	✓	-	✓	✓	-	✓
SDB 301-450mm	✓	✓	-	-	-	-
SDS 150-525mm	✓	✓	-	-	-	-
SPB 75-300mm	✓	-	✓	✓	✓	✓
PPS 150-300mm	✓	-	✓	✓	✓	✓
PPB 125-225mm	✓	-	✓	✓	✓	✓
SPV 75-300mm	✓	✓	-	✓	✓	-
PPV 125-225mm	✓	✓	-	✓	✓	-
Staifix Cavity Starter Tie	✓	✓	-	✓	✓	-
Staifix Frame Tie	✓	✓	-	✓	✓	-
Staifix StarterTie	✓	✓	-	✓	✓	-
STF6 50mm, 75mm, 100mm	✓	✓	-	✓	✓	-
TJ2 205, 230, 255, 280, 305mm long	✓	✓	-	✓	✓	-
Acoustic Tie 175-300mm	✓	✓	-	✓	✓	-
SD21,25,28 125-300mm	✓	-	✓	✓	-	21,25
SP21,28,30,38,36 75-200mm	✓	✓	-	✓	-	21
DT 150-300mm	✓	✓	-	✓	-	-
SPS 150-300mm	✓	-	✓	✓	-	-
SPS CJ 150mm	✓	-	✓	✓	-	-
TFMT7 50-150mm cavity	✓	✓	-	✓	-	-
Tim6 175, 200, 225, 250mm	✓	✓	-	✓	-	-
PP21 125-225mm	✓	✓	-	✓	-	-
PP28,30,36,38 125mm-300mm	✓	✓	-	✓	-	-
SD30,38,40 125mm-300mm	✓	✓	-	✓	-	-
SDV 125-300mm	✓	✓	-	✓	-	-
Briclok	✓	✓	-	✓	-	-
Column Tie 125mm - 300mm	✓	✓	-	✓	-	-
HiT Tie	✓	✓	-	✓	-	-
Internal Column Tie 179, 186, 224 and 232mm	✓	✓	-	✓	-	-
WHX 150-200mm	✓	✓	-	✓	-	-
Y,M,L,D,Z End Ties	✓	✓	-	✓	✓	-

# Wall Ties and Restraint Fixings

## For building with brick, block and stone

Wall ties and restraint fixings are an essential element in the stability of masonry panels.

Leviat manufactures Ancon restraint ties in a variety of lengths and types for restraining brickwork, blockwork and stonework. Restraints can be fixed to a variety of substrates including concrete, structural steelwork, SFS, timber and all types of masonry.

Products are manufactured from stainless steel unless stated otherwise.

The range of standard ties provides a solution for all types of wall construction and many products can be delivered in 24 hours. These items are shown in *red italics*.

### BIM

A number of Ancon wall ties are available as BIM Objects for use in a 3D building model and its associated component database. Visit [www.ancon.co.uk/BIM](http://www.ancon.co.uk/BIM) or the NBS National BIM Library to download our objects in Revit, IFC, ArchiCAD, Vectorworks and Bentley file formats.

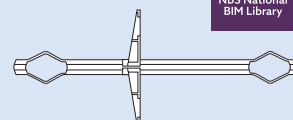

Dedicated sales and technical support



Distributors nationwide



CPD Seminars available



Webinars available online



Product information in NBS format



ISO 9001, ISO 14001 & ISO 45001



BIM Objects available



UKCA and CE or CE UKNI Compliance

## Contents

<a href="#">Cavity Wall Tie Selection</a>	<a href="#">6-8</a>	<a href="#">Standard Wall Ties</a>	<a href="#">21-22</a>
<a href="#">Installation Guidance</a>	<a href="#">9</a>	<a href="#">Bespoke Wall Tie References</a>	<a href="#">23</a>
<a href="#">Ties for Brick-to-Block Construction</a>	<a href="#">10-12</a>	<a href="#">Non-Drill Fixings for Steelwork</a>	<a href="#">24-25</a>
<a href="#">Two Part Ties</a>	<a href="#">12</a>	<a href="#">Head Restraints &amp; Sliding Anchors</a>	<a href="#">26-27</a>
<a href="#">Ties for Bubble Foil Insulation</a>	<a href="#">12</a>	<a href="#">Acoustic Wall Ties</a>	<a href="#">28</a>
<a href="#">Ties for Steel Studwork</a>	<a href="#">13</a>	<a href="#">Wall Starter Systems</a>	<a href="#">29</a>
<a href="#">Ties for Thin-Joint Blockwork</a>	<a href="#">14</a>	<a href="#">Restraints for Stone Cladding</a>	<a href="#">30-32</a>
<a href="#">Ties for Timber Frames</a>	<a href="#">15</a>	<a href="#">Remedial Wall Ties</a>	<a href="#">33-34</a>
<a href="#">Frame Cramps and Channel Ties</a>	<a href="#">16-19</a>	<a href="#">Staifix-Thor Helical Crack Stitching Kit</a>	<a href="#">35</a>
<a href="#">Vertical Movement Joints</a>	<a href="#">20</a>	<a href="#">Other Ancon Products</a>	<a href="#">35</a>

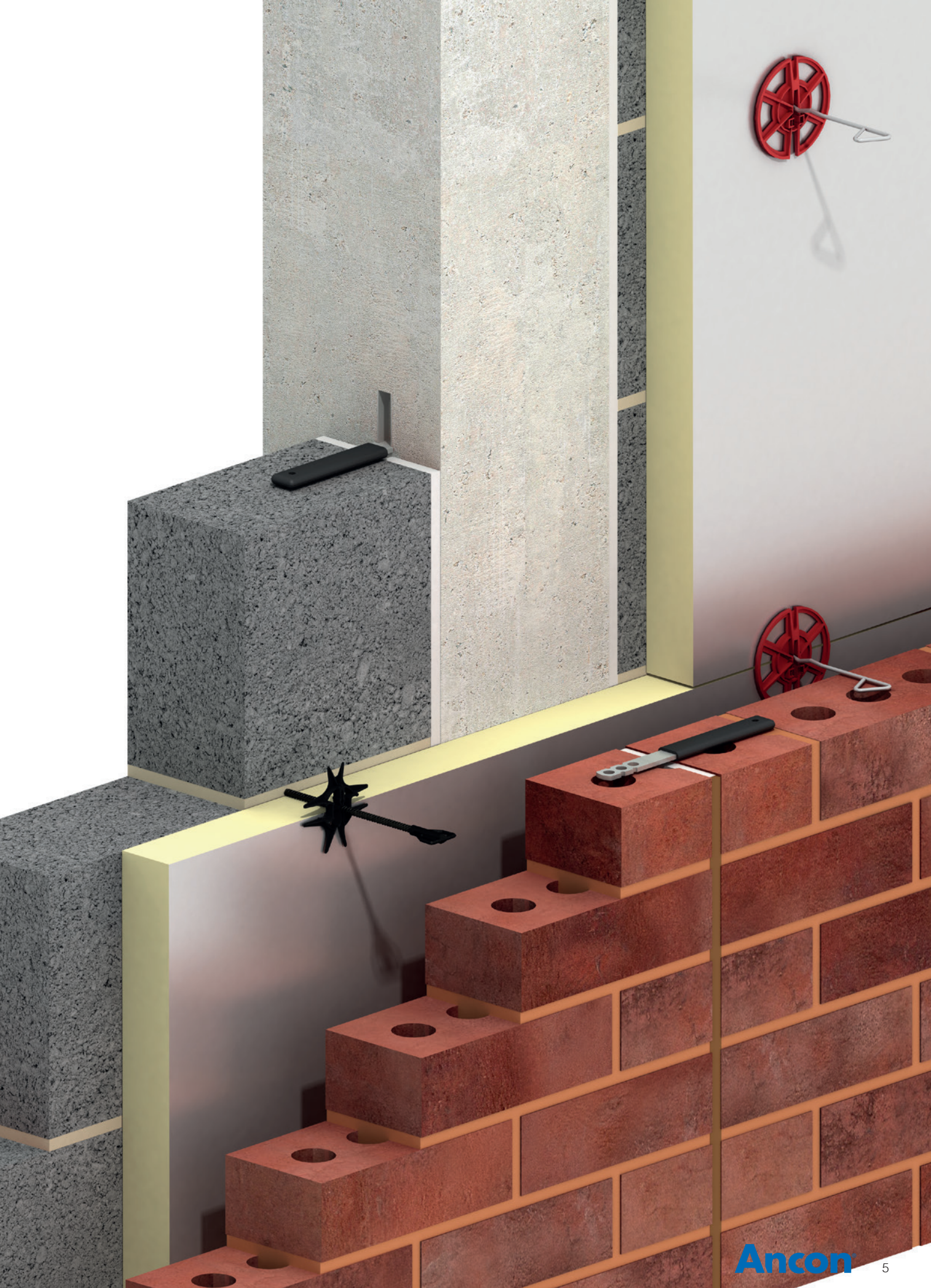

# Wall Ties and Restraint Fixings



© Hazle McCormack Young

## Cavity Wall Tie Selection

The selection and spacing of wall ties depend on many factors. These include type of masonry to be tied, cavity width, type and height of building and geographical location. There are several documents which need to be consulted and are summarised here.

### Eurocode 6 – Design of Masonry Structures (BS EN 1996-1-1: 2005)

In 2010, Eurocode 6 became the main code for the design of reinforced and unreinforced masonry. Eurocode 6 refers to EN 845-1 for wall ties and sets the density of ties per square metre based on the declared value of the tie. The material factor of 3.0 for detailed calculations is specified in the UK National Annex.

### BS EN 845-1: 2013 Specification for Ancillary Components for Masonry – Part 1: Wall Ties, Tension Straps, Hangers and Brackets

This European Standard specifies the requirements for wall ties used for interconnecting masonry and for connecting masonry to beams, columns or other parts of the building. Materials, tolerances, tie variations and the requirements for declared values, are all covered in this standard. For tie Types and qualifying criteria refer to PD 6697: 2019.

### PD 6697: 2019 Recommendations for the design of masonry structures to BS EN 1996-1-1 and BS EN 1996-2

Published Document 6697 contains non-contradictory, complementary information from the withdrawn British Standard BS 5628, which was not included in the BS EN 1996 series.

It includes recommendations on tie lengths, embedment, density, material and positioning. Masonry-to-masonry ties are classified as Types 1 to 4; the relevant classification is determined by strength, function and use. Minimum declared values for tension and compression are listed on page 7 for each tie Type.

### Approved Document E: Resistance to the Passage of Sound

This document specifies the acoustic performance requirements of ties suitable for use in separating walls (Type A) and external walls (Type B) of new build dwellings.

Type A ties must have a measured dynamic stiffness of  $<4.8\text{MN/m}^3$  for the specified minimum cavity, at a standard density. Type A ties in this literature are indicated by this logo e.g. Staifix HRT4, page 10.

All Ancon ties which cross a cavity meet the requirements of Type B.



### BS 5628, Code of Practice for the Use of Masonry

BS 5628 was withdrawn when the Eurocode became the accepted National code in March 2010. The majority of information in this British Standard has been reproduced in PD 6697: 2019.

### BS 5268-6.1: 1996 (Incorporating Amendments No. 1 and 2): Structural use of timber – Dwellings not exceeding seven storeys

BS 5268 provides recommendations for wall ties for timber framed buildings. Information is provided for the type of structure, location, embedment, density and positioning. These ties are classified as Types 5 to 7; minimum declared values in tension and compression are listed for Types 5 and 6.

Although BS 5268 was officially withdrawn on the full implementation of Eurocodes in March 2010, timber frame wall ties should continue to be selected from Types 5 to 7 as given in Annex B of BS 5268 Part 6.1: 1996, until further guidance is made available.

### Wind Code Variations

Masonry wall ties should be selected from the Types in PD 6697: 2019 and timber frame wall ties should be selected from the Types in BS 5268. These two documents use different Wind Codes.

The maximum wind speeds referred to in PD 6697: 2019 are based on ten minute return periods according to the current Wind Code BS EN 1991-1-4: 2005.

The geographical locations in BS 5268-6.1 are based on hourly return period wind speeds according to BS 6399-2: 1997.

Wall tie types and appropriate wind speed maps relevant to each wind code are shown on page 7. However we encourage specifiers to refer to the relevant code for complete information prior to making a specification.

### Wall Tie Product Selector

Available on our Ancon website, this easy to use product selector enables selection of the most appropriate wall ties for your application. Simply answer a series of multiple choice questions about wall type, inner leaf construction, building type and height, insulation and cavity width, to arrive at the required solution.



© Irvine Whitlock



© Green Building Store

**Minimum Requirements for Wall Ties to PD 6697: 2019 (Table 12) and BS 5268-6.1: 1996 (Annex B)**

Type of Tie	Minimum Mortar Class and Designation	Tensile Load Capacity (N)	Compressive Load Capacity (N)
1	M2 (iv)	2500	2000
2	M2 (iv)	1800	1050
3	M2 (iv)	1100	650
4	M2 (iv)	650	350
5	M4 (iii)	600	425
6	M4 (iii)	630	440
7	M4 (iii)	To be declared by the Wall Tie Manufacturer	

**Masonry-to-Masonry Wall Tie Types to PD 6697: 2019**

Type	Application	Density	Maximum Building Height	Geographical Location
<b>Type 1</b>	Heavy duty tie suitable for most building sizes and types. Not very flexible and not recommended for applications where there is expected to be excessive differential movement between leaves	2.5 ties/m <sup>2</sup> 3-4 ties/m <sup>2</sup> at unbonded edges	Any Height	Suitable for most sites. However, for relatively tall or unusually shaped buildings in vulnerable areas such as coastal sites, the tie provision should be calculated
<b>Type 2</b>	General purpose tie for domestic and small commercial buildings made with box-form masonry walls	As Type 1	15m	Suitable for flat (less than 1 in 20) open sites where the fundamental basic wind velocity does not exceed 31m/s and altitude is not more than 150m above sea level. Could be adequate for higher altitudes and sloping sites exceeding 1 in 20, if calculated.
<b>Type 3</b>	Basic wall tie generally as Type 2 above	As Type 1	15m	As Type 2 but fundamental basic wind velocity limited to 27m/s
<b>Type 4</b>	Light duty wall tie suitable for box-form domestic dwellings with leaves of similar thickness	As Type 1	10m	Suitable for flat sites (less than 1 in 20) in towns and cities where the fundamental basic wind velocity does not exceed 27m/s and altitude is not more than 150m above sea level

Note: Fundamental basic wind velocity must be calculated for the specific altitude of the site, refer to Clause NA.2.4 in NA to BS EN 1991-1-4:2005. The table above provides only a brief summary of information. Refer to PD 6697:2019 and NA to BS EN 1991-1-4:2005 for complete information.

**Lime Mortars**  
Ancon stainless steel wall ties and Teplo-BF wall ties are suitable for use with lime mortars (minimum strength HLM2); tie selection should be based on the general guidance given here.

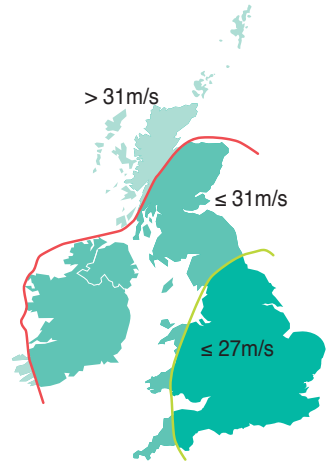

Information adapted from NA to BS EN 1991-1-4:2005 for use with PD 6697:2019, calculating  $c_{alt}$  for an altitude of 150m above sea level. For some projects this may be conservative. Contact Leviat for further details.

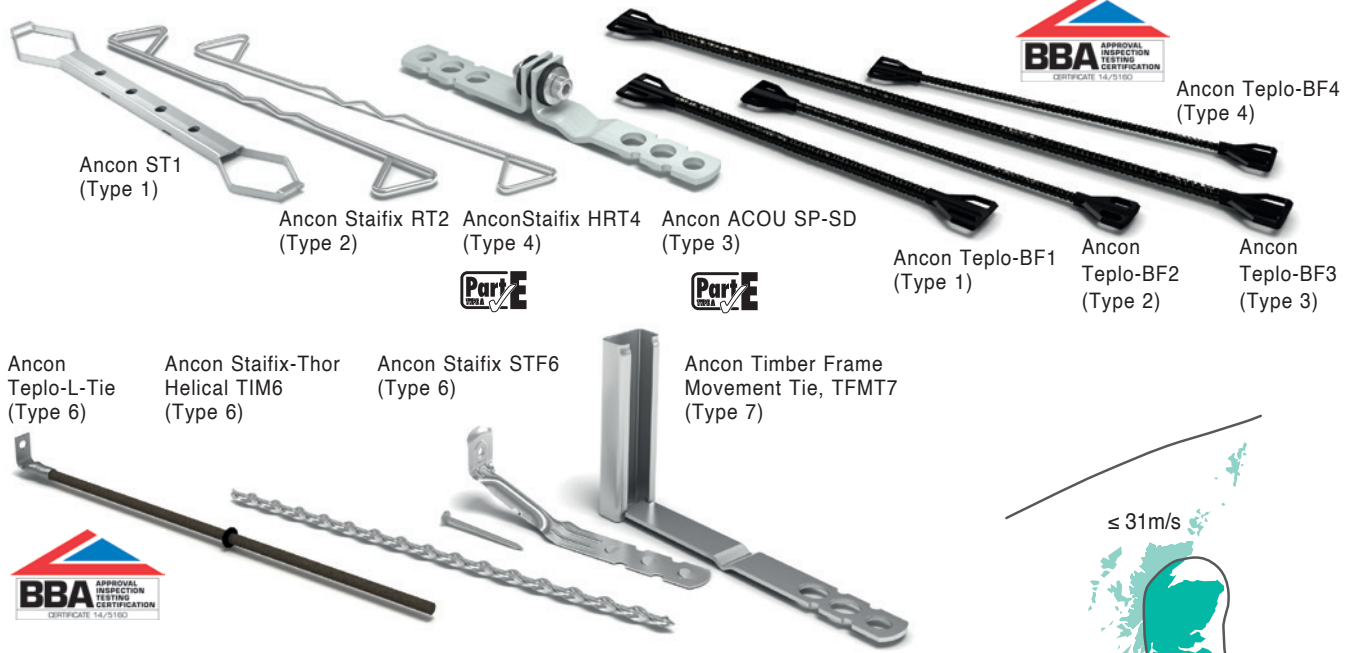

**Masonry-to-Timber Tie Types to BS 5268-6.1: 1996**

Type	Application	Density	Maximum Building Height	Geographical Location
<b>Type 5</b>	Timber frame tie suitable for domestic houses and industrial/ commercial developments of up to three storeys	4.4 ties/m <sup>2</sup> 3-4 ties/m at unbonded edges	15m	Suitable (at a density of 4.4 ties/m <sup>2</sup> ) for buildings on flat sites in towns and cities where the basic wind speed does not exceed 25m/s and altitude is not more than 150m above sea level. In more severe situations the tie density should be increased to 7 ties/m <sup>2</sup>
<b>Type 6</b>	As Type 5 but suitable for developments of up to four storeys	As Type 5	15m	Suitable (at a density of 4.4 ties/m <sup>2</sup> ) for buildings on flat sites in towns and cities where the basic wind speed does not exceed 25m/s and altitude is not more than 150m above sea level. In more severe situations the tie density should be increased to 7 ties/m <sup>2</sup>
<b>Type 7</b>	As Type 5 but suitable for developments of between five and seven storeys, being designed to accommodate the increased vertical differential movement	Calculated for actual performance required for each site location	15m	Calculated for actual performance required for each site location

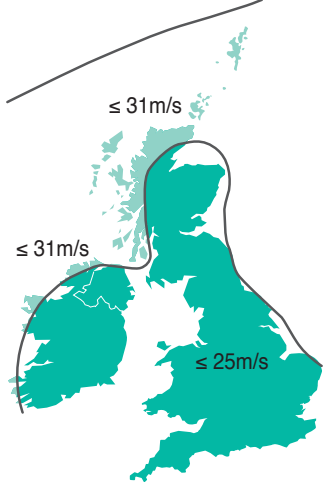

Wind speed information taken from BS 6399-2:1997 Code of Practice for Wind Loads for use with BS 5268-6.1:1996.

Note: Refer to BS 5268-6.1: 1996 and BS 6399-2: 1997 for complete information.

# Wall Ties and Restraint Fixings

## Density & Positioning of Ties

PD 6697: 2019 recommends that for walls in which both leaves are 90mm or thicker, ties should be used at not less than 2.5 per square metre (900mm horizontal x 450mm vertical centres). Ties should be evenly distributed over the wall area, except around openings, and should preferably be staggered.

At vertical edges of an opening, unreturned or unbonded edges, and vertical expansion joints, additional ties should be used at a rate of one per 300mm height, located not more than 225mm from the edge.

A typical layout is shown below. Various details incorporating debonding ties at vertical movement joints are shown on page 20.

### Lime Mortars

Ancon stainless steel wall ties and Teplo-BF wall ties are suitable for use with lime mortars (minimum strength HLM2). Tie length, spacing and density should be the same as for cement mortars where the performance is based on M2 (iv).

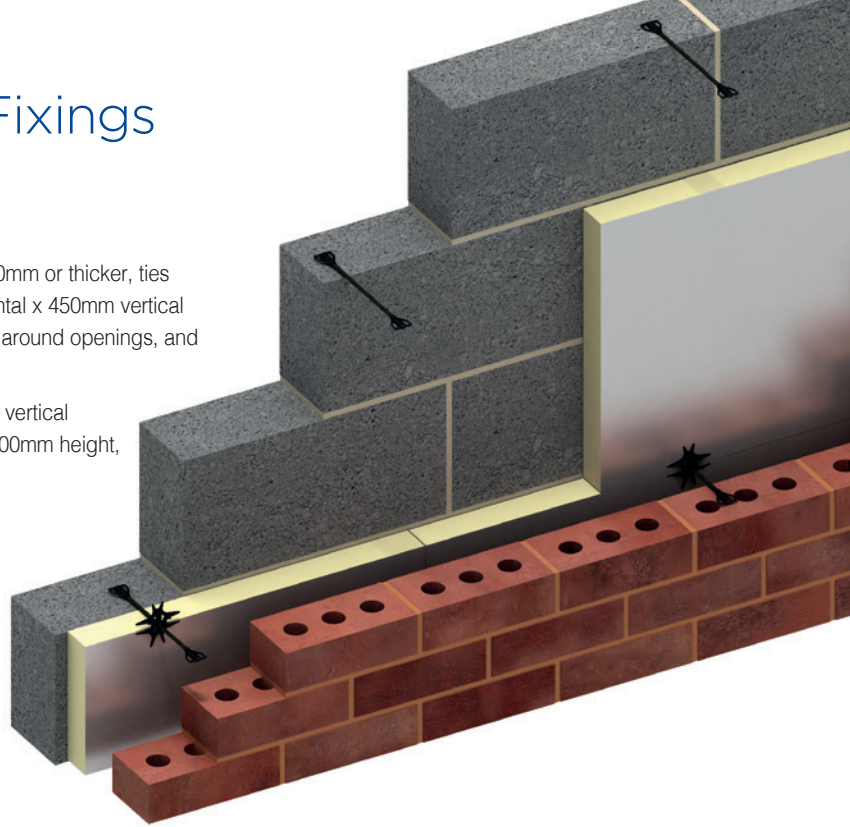

## Typical Layout of Wall Ties Indicating Maximum Spacing

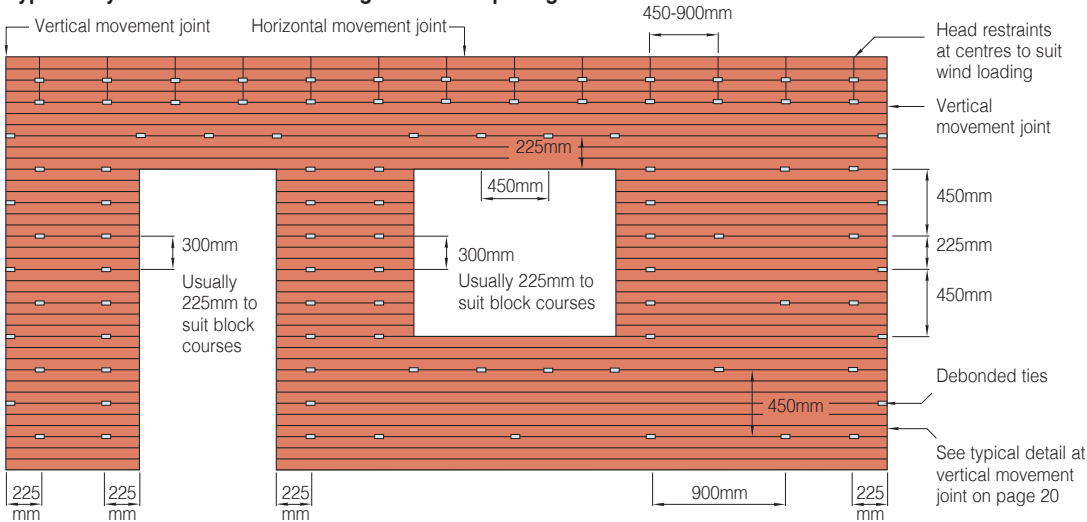

Standard spacing for cavity brickwork 900mm x 450mm centres in a staggered pattern (2.5 ties per square metre) Refer to PD 6697 : 2019 for complete information.

## Length of Tie & Embedment

Wall ties should be of the correct length to ensure they are properly embedded in the masonry.

Masonry-to-masonry wall ties are typically symmetrical and should be centred from the middle of the cavity to ensure equal embedment in each leaf.

The minimum embedment of symmetrical Ancon wall ties, i.e. ST1, RT2, HRT4 and Teplo-BF, is 50mm in each leaf and the PD 6697: 2019 Tie Types declared by us are backed by independent testing at this minimum embedment.

However, we recommend tie lengths which achieve a design embedment of between 62.5mm and 75mm in each leaf (see table), to allow for site tolerance in both cavity width and centring of the ties.

Cavity width on site should be monitored to ensure the correct wall tie length is used. If the cavity width grows to such an extent that the embedment range of the wall tie is exceeded, longer wall ties will be required. Please contact us for guidance.

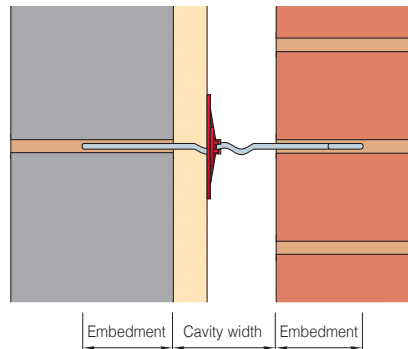

Embedment of Wall Ties

## Recommended Lengths of Masonry / Masonry Wall Ties

Cavity Width (mm)	Length of Wall Tie (mm)
50-75	200
76-100	225
101-125	250
126-150	275
151-175	300
176-200	325
201-225	350
226-250	375
251-275	400
276-300	425
301-325	450
326-350	475
351-375	500
376-400	525
401-425	550
426-450	575



## Installation Guidance

Wall ties are important to the stability of masonry and failure to install them correctly may lead to damp penetration, cracking or even the collapse of walls.

Wall ties should be pressed down in fresh mortar. They should be surrounded by mortar and not simply positioned directly onto masonry with mortar placed around them. To ensure cavity wall ties are effective at tying the leaves together they should be installed as the inner leaf is constructed and not simply pushed into a joint.

Ideally, ties should be installed level or with a slight fall to the outer leaf, not towards the inner leaf as this could provide a path for moisture to cross the cavity.

The drip part of the tie should point downward and be positioned near the centre of the open cavity. Ties with multiple drips, like the Ancon Staifix and Ancon ST1, should be positioned centrally as a drip will normally be near the centre of the open section of a partial fill cavity.

Installed ties should be clear of mortar droppings to allow the drip to function and prevent water from crossing to the inner leaf of masonry.

The practice of bending up installed wire ties should be discouraged. This can adversely affect the performance of the tie and weaken the embedment in the inner leaf. Rigid ties like the Ancon SDS and ST1 should never be bent on site.

There is a risk of injury if wall ties are left protruding from a single wall leaf before the second leaf is constructed. Site managers should make all workers and visitors aware of this risk.

Installation guides can be downloaded from [www.ancon.co.uk](http://www.ancon.co.uk)

To reduce the risk of injury, Ancon wall ties feature rounded safety ends, however, we recommend both leaves of a cavity wall are built simultaneously to eliminate any risk of injury from protruding ties.

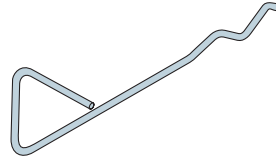

Staifix Safety End

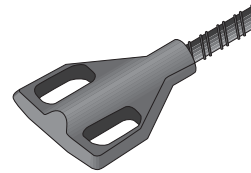

Teplo-BF Moulded Safety End

Ancon frame ties and channel ties are manufactured with a non-spread safety end allowing the use of a debonding sleeve. This type of safety end reduces the variety of ties required on site.

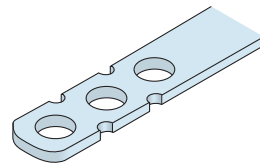

Ancon Non-Spread Safety End

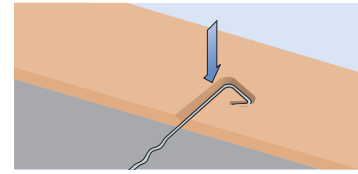

Wall ties should be pressed down in, and then surrounded by, fresh mortar.

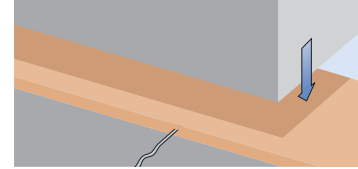

To ensure cavity wall ties are effective at tying the leaves together they should be installed as the inner leaf is constructed and not simply pushed into a joint.

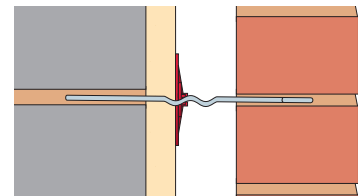

Ties should be installed with a slight fall to the outer leaf, never towards the inner leaf as this could provide a path for moisture to cross the cavity.

Wall Ties with Insulation Retaining Clips

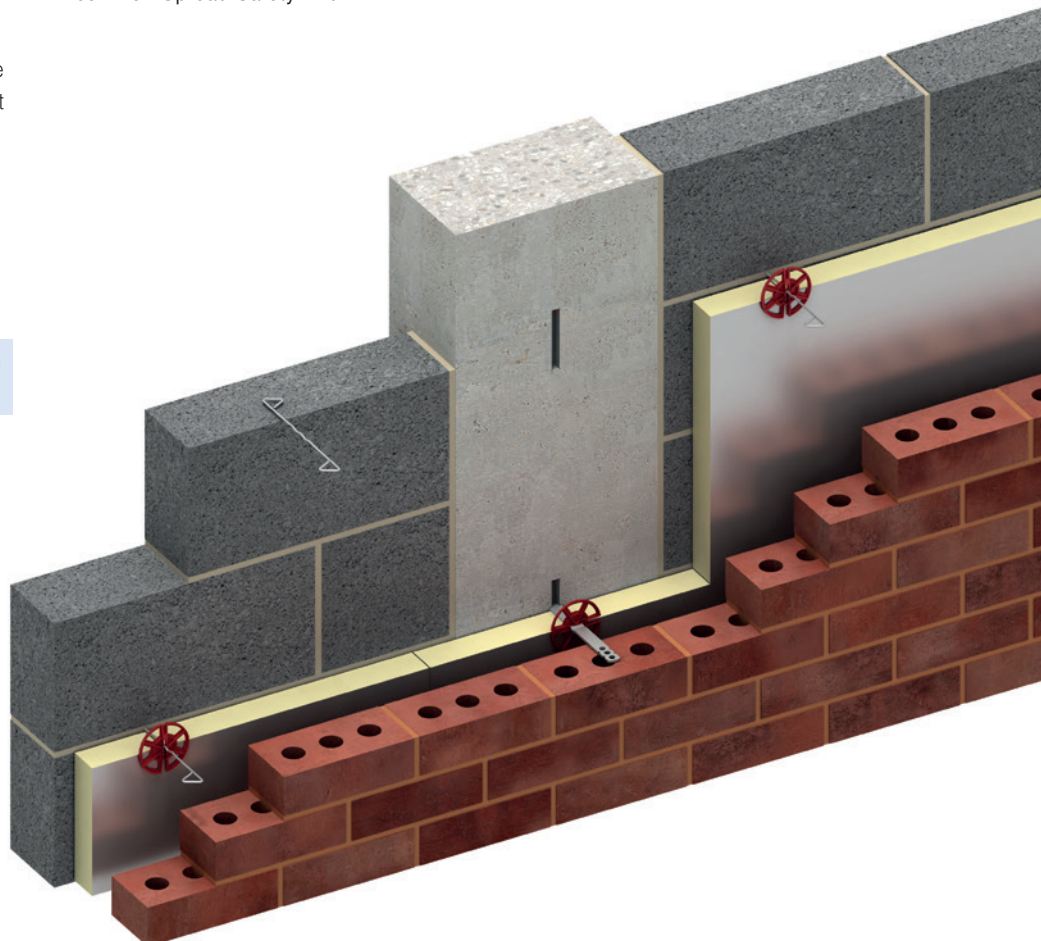

# Wall Ties and Restraint Fixings

## Low Thermal Conductivity Wall Ties to PD 6697: 2019 for Brick-to-Block Construction

### Ancon ST1 Type 1 Tie (Masonry Heavy Duty)

The Ancon ST1 is suitable for cavities from 50mm to 225mm and can be used for all types of buildings of any height, anywhere in the British Isles. The section that spans the cavity has a series of holes to provide water drips. The ST1 has a measured dynamic stiffness of  $<113\text{MN/m}^3$  that meets the performance requirement of Approved Document E for use in external masonry walls. For internal separating walls of new-build attached dwellings see HRT4. Type 1 performance is declared in M2 mortar.

### Ancon Staifix RT2 Type 2 Tie (Masonry General Purpose)

The Staifix RT2 is a general purpose tie. It is suitable for cavities from 50mm to 150mm and can be used for domestic houses and small commercial buildings up to 15 metres in height (see page 7 for geographical restrictions). In many cases, Staifix RT2 wall ties can be used in buildings greater than 15 metres if shown to be adequate by calculation. For further information please contact our Technical Services Team. The RT2 has a measured dynamic stiffness of  $<113\text{MN/m}^3$  that meets the performance requirement of Approved Document E for use in external masonry walls. For internal separating walls of new-build attached dwellings see HRT4.

### Ancon Staifix HRT4 Type 4 / Type A Tie (Masonry Light Duty)

The Staifix HRT4 is available for cavities from 50mm to 150mm. As a Type 4 tie it is suitable for use in external walls of domestic houses up to 10 metres in height (see page 7 for geographical restrictions).

The HRT4 is a Type A tie for separating walls of any height. Independent tests have proven the Staifix HRT4 has a measured dynamic stiffness of  $<4.8\text{MN/m}^3$  when installed at a standard  $2.5\text{ties/m}^2$  spacing and is therefore suitable for internal separating (party) walls of new-build attached dwellings with cavities from 50mm to 150mm. The HRT4 can be used with all approved robust details for cavity masonry separating walls, whether traditional or thin-joint blockwork (suitable for thin-joint construction with 3mm thick joints). Use of these details eliminates the need for pre-completion sound testing. For wall ties with greater acoustic resilience, see page 28.

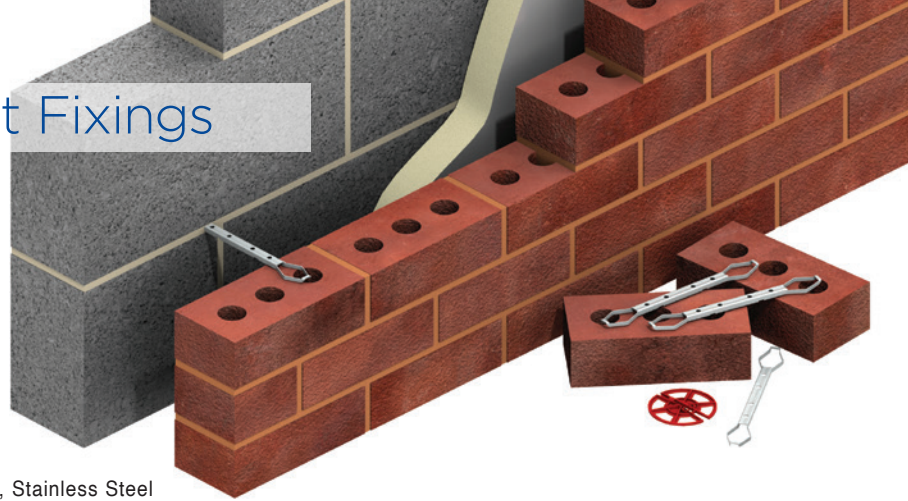

#### Ancon ST1, Stainless Steel

- 200mm for 50-75mm cavities
- 225mm for 76-100mm cavities
- 250mm for 101-125mm cavities
- 275mm for 126-150mm cavities
- 300mm for 151-175mm cavities
- 325mm for 176-200mm cavities
- 350mm for 201-225mm cavities

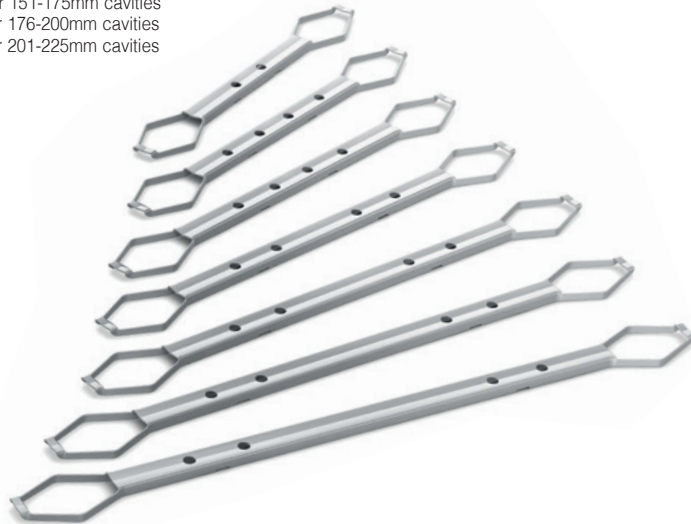

#### Ancon Staifix RT2, Stainless Steel

- 200mm for 50-75mm cavities
- 225mm for 76-100mm cavities
- 250mm for 101-125mm cavities
- 275mm for 126-150mm cavities

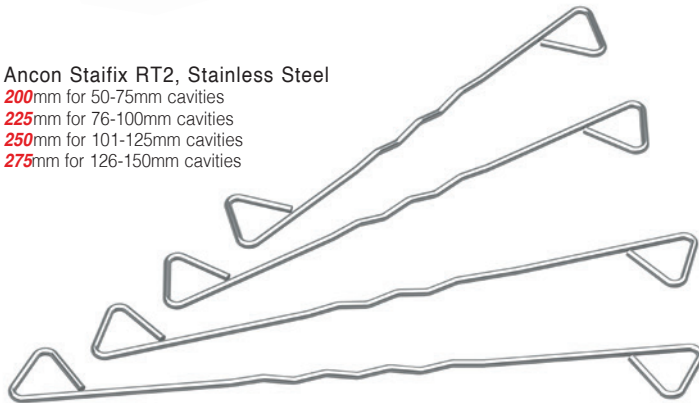

#### Ancon Staifix HRT4, Stainless Steel

- 200mm for 50-75mm cavities
- 225mm for 76-100mm cavities
- 250mm for 101-125mm cavities
- 275mm for 126-150mm cavities

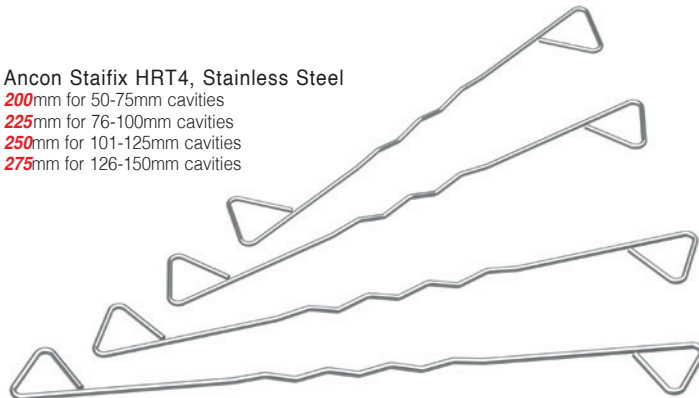

### Ancon Teplo-BF

The Ancon Teplo-BF is suitable for cavities from 50mm to 450mm and is manufactured from pultruded basalt fibres. This material has a thermal conductivity of only 0.7W/mK which can be shown in U-value calculations to reduce insulation thickness and wall footprint.

The Ancon Teplo-BF range comprises Teplo-BF1 (Type 1), Teplo-BF2 (Type 2), Teplo-BF3 (Type 3) and Teplo-BF4 (Type 4). Please refer to page 7 for further details on the suitability of each wall tie at the standard spacings. Decreasing wall tie centres can increase performance level e.g Type 3 to Type 2. Contact us for more information.

The Ancon Teplo range has BBA approval and can be used in line with NHBC standards. It also meets the performance requirement of Approved Document E for use in external masonry walls. For internal separating walls of new-build attached dwellings use HRT4.

Plain-ended Teplo-R ties, inspired by the original basalt-fibre wall tie, are ideal for resin-fixed remedial/ retrofit projects.



Also available is the Teplo-BFR featuring a plain end for anchoring with resin and a moulded safety end for building into a bed joint. This product is ideal for use when mortar joints do not align or when a new leaf of masonry is being added to an existing masonry or concrete structure.

Visit [www.ancon.co.uk](http://www.ancon.co.uk) to download a product datasheet.



### Low Thermal Conductivity Wall Ties

Wall ties are an essential element in the strength and stability of cavity walls, but by crossing the cavity they act as a thermal bridge between the internal and external leaves. The ties featured here on pages 10-11 form our Low Thermal Conductivity range; cavity ties which minimise heat loss and improve the energy-efficiency of a masonry wall. With a thermal conductivity of only 0.7W/mK, Ancon Teplo wall ties are the most thermally-efficient products in the range and are excluded from U-value calculations to BS EN ISO 6946.

For the accurate calculation of a wall's U-value it is important to use the correct information for the wall ties. Using the actual cross-sectional area and thermal conductivity value of a wall tie, rather than allowing a program to apply default values, can make a considerable difference to the calculated U-value. Default values will over-estimate the effect of an Ancon Wall Tie. The effect our high tensile wire wall ties have on heat transfer is negligible.

### Ancon Teplo-BF1/2/4, Basalt-Fibre

200mm for 50-75mm cavities  
225mm for 76-100mm cavities  
250mm for 101-125mm cavities

### Ancon Teplo-BF1/2, Basalt-Fibre

275mm for 126-150mm cavities

### Ancon Teplo-BF2, Basalt-Fibre

300mm for 151-175mm cavities  
325mm for 176-200mm cavities  
350mm for 201-225mm cavities  
375mm for 226-250mm cavities  
400mm for 251-275mm cavities  
425mm for 276-300mm cavities

### Ancon Teplo-BF3, Basalt-Fibre

450mm for 301-325mm cavities  
475mm for 326-350mm cavities  
500mm for 351-375mm cavities  
525mm for 376-400mm cavities

### Ancon Teplo-BF4, Basalt-Fibre

550mm for 401-425mm cavities  
575mm for 426-450mm cavities



Teplo-BF is available in a range of diameters and lengths to suit cavities from 50mm to 450mm

### Cross-Sectional Areas and Thermal Conductivity of Ancon Wall Ties

Tie Reference	Tie Length (mm)	Cavity Width (mm)	Tie Type to PD 6697: 2019	Area (mm <sup>2</sup> )	Thermal Conductivity* (W/mK)
ST1	200	50-75	1	19.5	17
	225	76-100	1	19.5	17
	250	101-125	1	19.5	17
	275	126-150	1	23.4	17
	300	151-175	1	23.4	17
	325	176-200	1	23.4	17
RT2	350	201-225	1	23.4	17
	200	50-75	2	8.6	17
	225	76-100	2	8.6	17
HRT4	250	101-125	2	8.6	17
	275	126-150	2	10.2	17
	200	50-75	4	3.5	17
Teplo-BF1	225	76-100	4	4.2	17
	250	101-125	4	6.2	17
	275	126-150	4	6.2	17
Teplo-BF2	200	50-75	1	38.5	0.7
	225	76-100	1	38.5	0.7
	250	101-125	1	38.5	0.7
	275	126-150	1	38.5	0.7
	200	50-75	2	19.6	0.7
	225	76-100	2	19.6	0.7
	250	101-125	2	19.6	0.7
	275	126-150	2	28.3	0.7
	300	151-175	2	28.3	0.7
	325	176-200	2	28.3	0.7
	350	201-225	2	38.5	0.7
	375	226-250	2	38.5	0.7
Teplo-BF3	400	251-275	2	38.5	0.7
	425	276-300	2	38.5	0.7
	450	301-325	3	38.5	0.7
	475	326-350	3	38.5	0.7
	500	351-375	3	38.5	0.7
	525	376-400	3	38.5	0.7
Teplo-BF4	200	50-75	4	12.6	0.7
	225	76-100	4	12.6	0.7
	250	101-125	4	12.6	0.7
	550	401-425	4	38.5	0.7
	575	426-450	4	38.5	0.7

**Note:** BS EN ISO 6946 permits the corrections due to wall ties, air gaps etc to be omitted, if the corrections amount to less than 3% of the uncorrected U-value of the element. \*Wall Ties with a thermal conductivity of less than 1.0W/mK e.g. Teplo, are excluded from U-value calculations to BS EN ISO 6946, irrespective of cross-sectional area.

# Wall Ties and Restraint Fixings

## Ancon Two-Part Tie

Long ties for cavities of 150mm and above can often be difficult to balance and keep horizontal when built into the inner leaf. As an alternative, our Ancon Two-Part Tie has one section built into the blockwork and a second section is then fixed as the outer leaf is built. An embedment of 75mm is required at each end. The inner tie is usually manufactured in lengths of 170mm with variation in the cavity width being accommodated by the length of the outer section. Where insulation thickness is in excess of 60mm, the inner section should be longer than the standard 170mm to ensure the connection between the two parts is made in the open cavity.

To specify or order this tie simply quote 'Ancon Two-Part Tie to suit \_\_ \_mm cavity with an insulation thickness of \_\_ \_mm'. The black TJ Insulation Retaining Clip is recommended for use with the inner section.

Using the standard inner section, Ancon Two-Part Ties sustain loads which exceed the requirements for a Type 2 tie to PD 6697: 2019 for cavities up to 400mm.

### Recommended Fixing Centres for Two-Part Ties

Inner Section (mm)	Cavity (mm)	Type 1	Type 2	Type 3
170	150-400	600x450	900x450	900x450
171-230	150-400	375x450	750x450	900x450

**Notes:** Centres shown achieve equivalent tie type performances to PD 6697: 2019. See page 7 for details.

### Ties for Bubble Foil Insulation

A range of ties are manufactured under license from Thermal Economics Ltd for use with Bubble Foil Insulation. These ties are available as Type 2, Type 3 and Type 4 ties to PD 6697: 2019. CB referenced ties enable the insulation material to be installed flush to the blockwork. AF referenced ties position the insulation 25mm away from the block. These ties can be used in line with NHBC standards.

Wall Tie Reference	PD 6697 Type	Length (mm)	Cavity Range (mm)
WT4-CB-185	4	185	50-60
WT4-CB-200	4	200	60-75
WT4-CB-225	4	225	85-100
WT4-CB-250	4	250	110-125
WT4-AF-200	4	200	60-75
WT4-AF-225	4	225	85-100
WT2-CB-185	2	185	50-60
WT2-CB-200	2	200	60-75
WT2-CB-225	2	225	85-100
WT2-AF-200	2	200	60-75
WT2-AF-225	2	225	85-100
WT3-AF-250	3*	250	110-125

**Notes:** Refer to page 7 for more information on Type 4, Type 3 and Type 2 ties. \* Type 2 tie at 450mm vertical x 850mm horizontal centres.

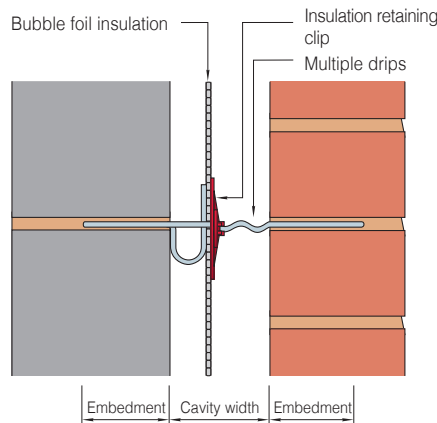
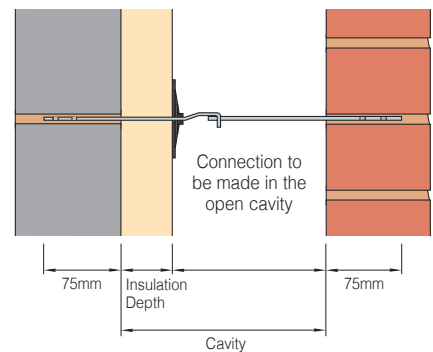
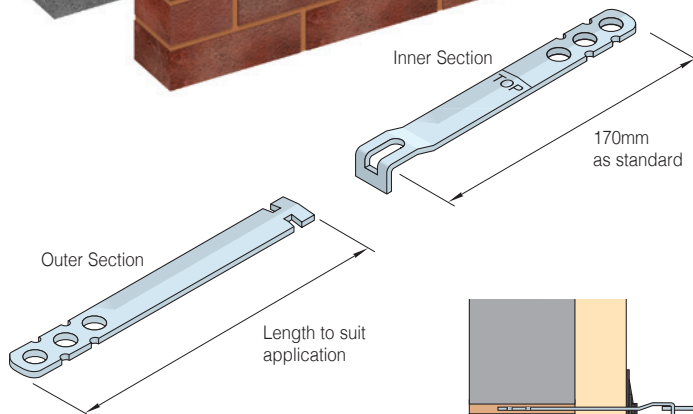
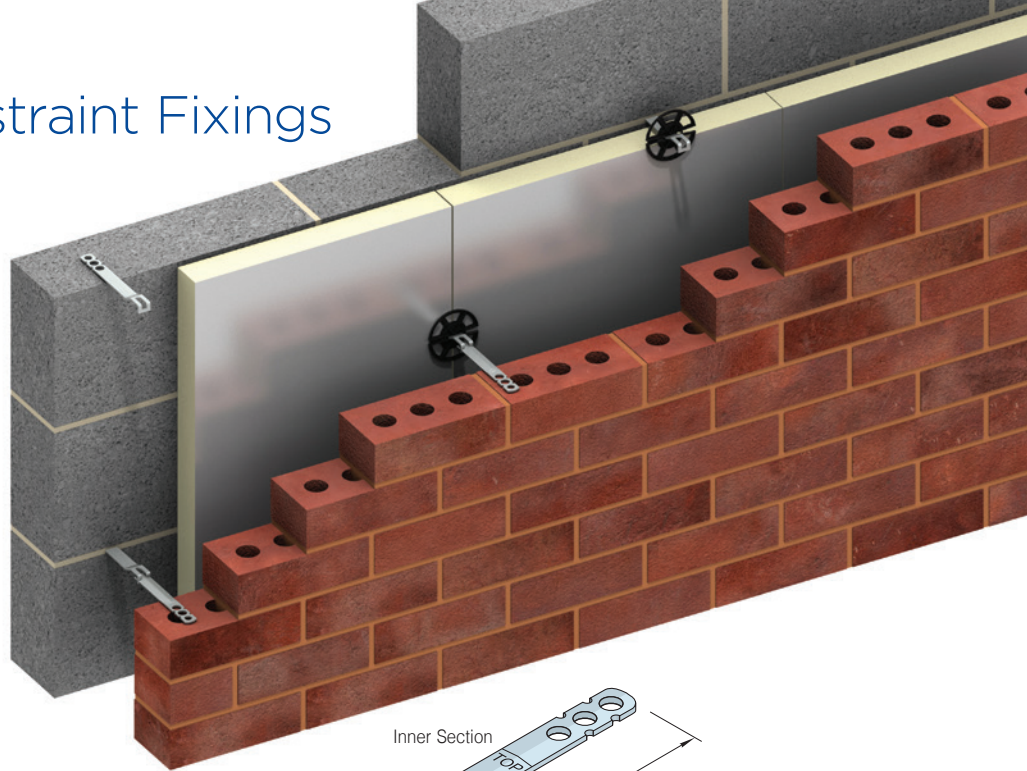

Installation of WT2-AF Wall Ties

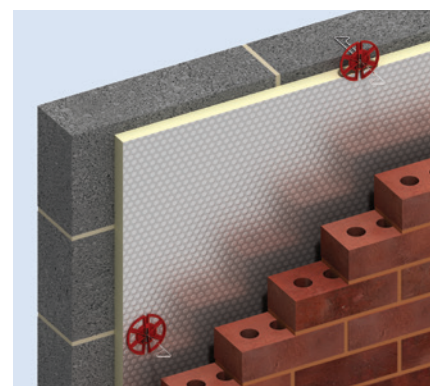

WT2-CB Wall Ties shown with Alreflex Ultratherm

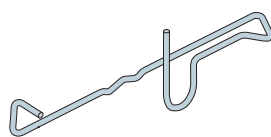

WT2-AF

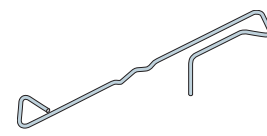

WT4-CB  
\*Lengths 185, 200mm



## Ancon 25/14 Restraint System

The Ancon 25/14 system is designed to tie masonry cladding to an in-situ structural frame, through a layer of insulation. It is suitable for use with steel, timber or concrete frames and any type of insulation.

The system comprises 25/14 Channel, SD25 or Teplo-BF-CT 25 Wall Ties, HT high thread (for fixing to steel/timber) or CFS (for fixing to concrete) Fixing Screws, and Compression Sleeves when required.

Ancon 25/14 channel features alternate 5.3mm and 9.5mm diameter holes to accept the two fixing types. Vertical centres vary for both fixing screws and wall ties, depending on the Tie Type performance required (see page 7 and table below).

We recommend that wall ties for the 25/14 system are designed to achieve a minimum embedment of 55mm in the masonry. SD25 ties are available in lengths from 100mm to 300mm to suit open cavities up to 259mm. Teplo-BF-CT 25 are available in lengths from 150mm to 375mm to suit open cavities up to 334mm.

The 25/14 system has been independently tested at Lucideon and is UKCA and CE marked to EN 845-1.

### Fixing to Steel/Timber

Self-drilling high-thread screws fix through the channel and the insulation and into the steel or timber framing system. These fixings are available for a combined backing board and insulation thickness of up to 220mm. They can be installed directly through the insulation when using any thickness of rigid insulation or when using ROCKWOOL Rainscreen Duo Slab®, Isover Polterm Max Plus, Kingspan Facades K-Roc Rainscreen Slab, Knauf Insulation Rocksilks® Rainscreen Slab, Xtratherm Stonewool and ROCKWOOL Nyrock® Rainscreen 032 with a maximum thickness of 180mm. When using more flexible insulation materials up to 220mm thick, an Ancon Compression Sleeve is required around the fixing screws.

### Fixing to Concrete

Ancon CFS screws fix through the channel and a stainless steel Ancon Compression Sleeve, located in the insulation, and into a pilot hole in the concrete. This system is suitable for all insulation types up to a thickness of 270mm.

CFS screws are also available for fixing the channel directly back to concrete where no insulation is present, for further information please contact us.

Note: concrete strength increases with age and care should be taken when fixing CFS screws into older concrete. Concrete screws are not recommended for use with concrete grades greater than C35/45. For further information and additional guidance on embedment depths and torque settings, please refer to our installation guide.

### Recommended Vertical Centres for Wall Ties & Fixing Screws

Tie Type	Maximum Backing Board & Insulation Thickness (mm)			Vertical Tie Spacing (mm)	Vertical Screw Spacing (mm)
	Steel	Timber	Concrete		
1	220	186	270	300**	225
2				450	337.5
3				450	337.5/450*
4				450	337.5/450*

**Notes:** Based on 25/14 Channel at 600mm horizontal centres. Centres shown achieve equivalent tie type performances to PD 6697: 2019, Table 12 (M2 mortar). See page 7 for more details on Tie Types. \*337.5mm centres for insulation thickness >114mm. \*\*225mm vertical tie spacing for Teplo-Channel Ties 300mm and longer.

Datasheets featuring wall tie and fixing screw references are available to help with specification. Visit [www.ancon.co.uk](http://www.ancon.co.uk) or contact us.

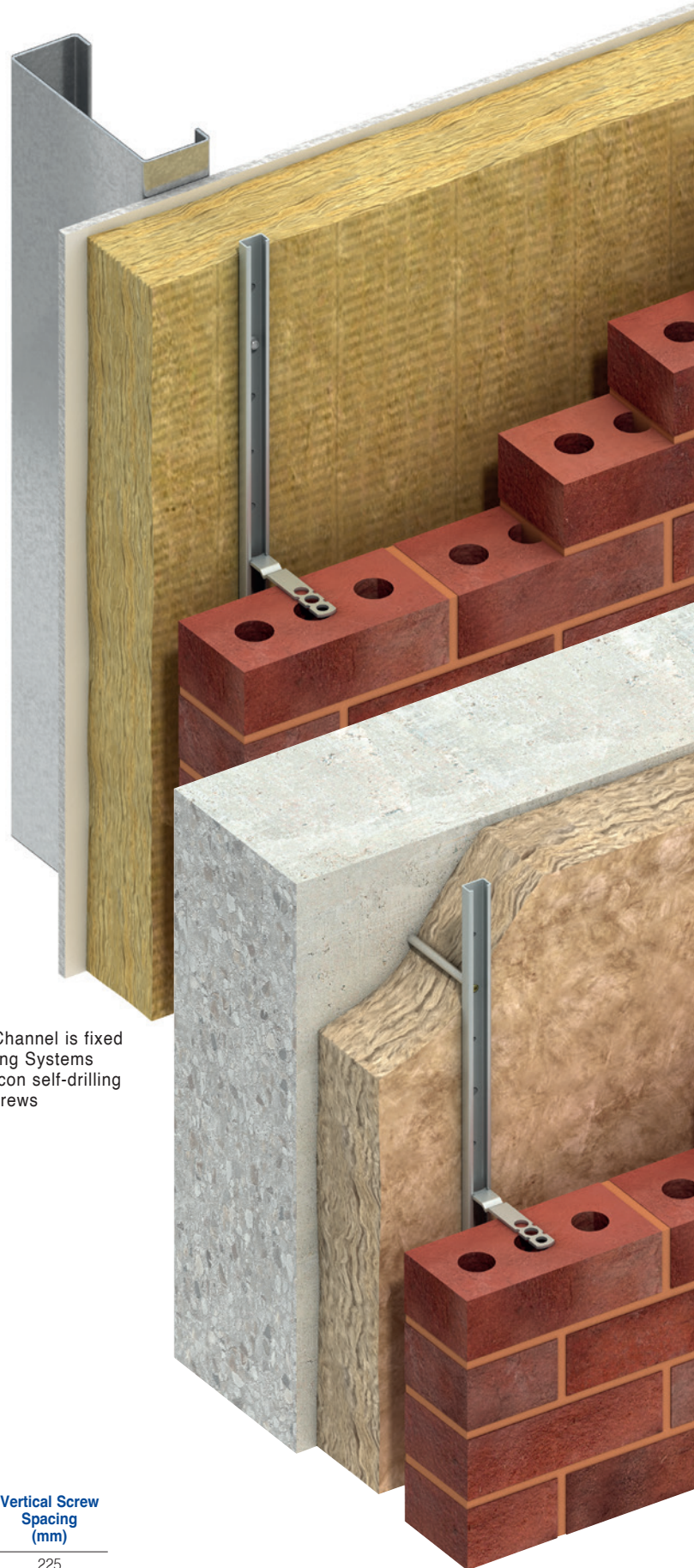

Ancon 25/14 Channel is fixed to Steel Framing Systems (SFS) with Ancon self-drilling high-thread screws

Ancon 25/14 Channel is fixed to concrete with Ancon CFS screws, through an Ancon Compression Sleeve located in the insulation

# Wall Ties and Restraint Fixings

## Ties for Thin-Joint Blockwork

### Staifix-Thor Helical TJ2 Wall Tie

The TJ2 wall tie hammers directly into aerated concrete blocks, through insulation material, and is built into the bed joints of the outer leaf of brickwork. It is ideal for thin-joint blockwork and other applications where the joints in the inner and outer leaves are not aligned.

This tie can be used in line with NHBC standards and meets the requirements of PD 6697: 2019 as a type 2 or 3 wall tie depending on the block used and the cavity width. The TJ2 has a cross-sectional area of 8.8mm<sup>2</sup>.

The helix of the Staifix-Thor Helical range differs from other helical fixings; each rotation interlocks perfectly down its length guaranteeing maximum performance. Tools are available to simplify installation.

The black Teplo Clip is designed for use with TJ2 wall ties.

### Staifix HRT4 Wall Tie

For thin-joint to thin-joint separating walls (min. joint thickness 3mm) use the Ancon Staifix HRT4 (see page 10).

### Ties for Cellular Clay Blocks

We developed an innovative range of wall ties for use with cellular clay blockwork, where the horizontal bed joints are just 1mm.

The range includes cavity wall ties for use with external brickwork, cavity wall ties for internal separating walls to Approved Document E and ties for connecting perimeter walls to internal walls.

Installation of the component parts of cavity wall ties in this range are phased which eliminates any danger of injury from wall ties projecting from a part-built cavity wall.

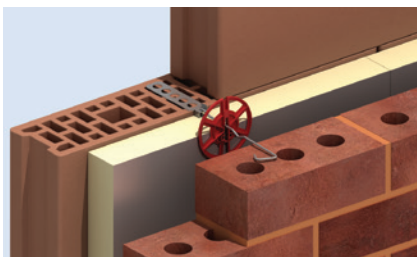

Ancon CCB4 Wall Tie

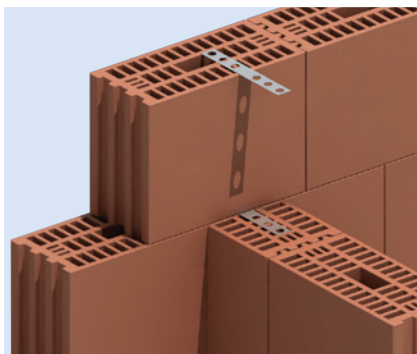

Ancon CCB-IWJ Ties for Internal Wall Junctions

## TJ2 to PD 6697: 2019

Block Strength (N/mm <sup>2</sup> )	Cavity Width (Tie Length)				
	50mm (205mm)	75mm (230mm)	100mm (255mm)	125mm (280mm)	150mm (305mm)
2.8	Type 3	Type 3	Type 3	Type 3	Type 3
3.5	Type 3	Type 3	Type 3	Type 3	Type 3
7.0	Type 2	Type 2	Type 2	Type 2	Type 2
10.0	Type 2	Type 2	Type 2	Type 2	Type 2

**Note:** For maximum building height and restrictions based on geographical location please refer to page 7.

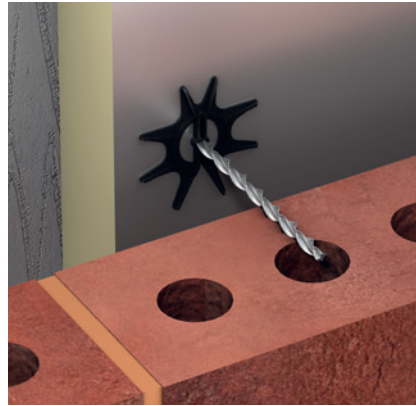

Staifix-Thor Helical TJ2 Thin-Joint Tie  
European Patent No. 1307303

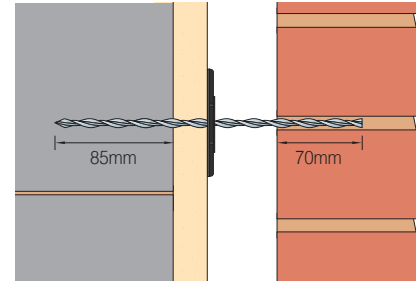

Embedment Depths

### TJ2 Recommended Lengths

Cavity Width (mm)	Tie Length (mm)
50	205
75	230
100	255
125	280
150	305

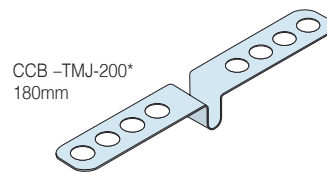

\*Declared Shear Value 280N

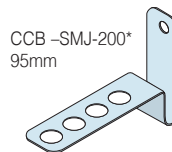

\*Declared Shear Value 280N

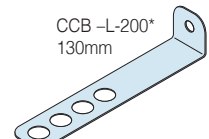

\*Declared Shear Value 690N

### CCB-JJ Ties (all 80mm embedment)

Product Ref.	Cavity Width (mm)	Tie Type
CCB-JJ-210	50	2
CCB-JJ-235	75	2
CCB-JJ-260	100	2
CCB-JJ-285	125	3
CCB-JJ-310	150	3
CCB-JJ-335	175	3
CCB-JJ-360	200	3

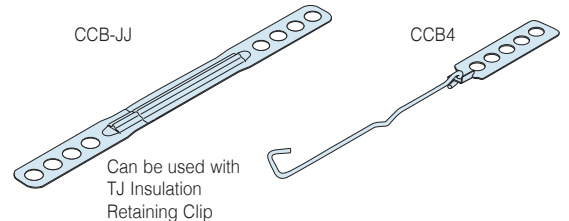

### Cellular Clay Block to Traditional Masonry

Product Reference	Cavity Width (mm)	Type Performance		
		Type 4 Performance	Type 3 Performance	Type 2 Performance
<b>Horizontal x Vertical Spacings (mm)</b>				
CCB4-100	100	900 x 450	600 x 450	450 x 450
CCB4-125	125	900 x 450	600 x 450	375 x 400
CCB4-150	150	900 x 450	450 x 450	-

**Notes:** At vertical edges of an opening, unreturned or unbonded edges, additional ties should be used at a rate of one per 300mm height, located not more than 225mm from the edge. For complete information on tie types refer to PD 6697: 2019.

### Cellular Clay Block to Cellular Clay Block for Internal Separating (Party) Walls

Cavity Width (mm)	Product Reference	Horizontal x Vertical Spacings (mm)
75	CCBA-75	900 x 450
100	CCBA-100	900 x 450

**Note:** Type A tie suitable for use in internal separating walls of any height to Approved Document E: Resistance to the Passage of Sound.

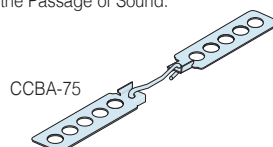

CCBA-75



### Flat Tie for connecting perimeter walls to internal walls

Product Reference	Length (mm)
CCB-IWJ-180	180

**Note:** For block widths greater than 140mm, two ties should be used per course.

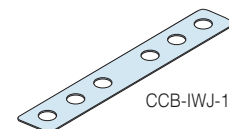

CCB-IWJ-180

## Ties for Timber Frames

There is a choice of three Ancon Type 6 Timber Frame Ties designed to fix brickwork or blockwork to timber-framed structures up to 4 storeys in height and accommodate maximum differential movement of 24mm; the Type 7 Ancon TFMT wall tie is available for other timber frame applications.

### Ancon Staifix Timber Frame Tie, STF6 (Type 6)

The Staifix STF6 tie is available in three lengths to suit 50mm, 75mm and 100mm cavities.

It is supplied complete with an annular ring shank nail. The tie is cranked to simplify correct installation and to prevent moisture from crossing the cavity. The STF6 has a cross-sectional area of 12mm<sup>2</sup> and stainless steel has a thermal conductivity of 17W/mK; this information is provided to aid U-value calculations.

The Staifix STF6 tie has been independently tested for use with 15mm OSB (Oriented Strand Board) SIPS Panel. The standard annular ring shank nail should be replaced with a 4 x 30mm stainless steel Spax® screw.

### Ancon Staifix-Thor Helical Timber Tie, TIM6 (Type 6)

The Staifix-Thor Helical TIM6 is available in four standard lengths. It is suitable for cavities from 50mm to 150mm and can be used with the red Staifix Universal Clip where insulation is to be retained in the cavity. An installation tool is required to hammer the tie into the timber frame. The TIM6 has a cross-sectional area of 6.6mm<sup>2</sup> and stainless steel has a thermal conductivity 17W/mK; this information is provided to aid U-value calculations.

We recommend a minimum embedment depth of 35mm in the timber frame and 65mm in the masonry leaf.

#### TIM6 (Type 6) Recommended Lengths

Tie Length (mm)	Cavity Width (mm)
175	50-75
200	76-100
225	101-125
250	126-150

### Ancon Timber Frame Movement Tie, TFMT7 (Type 7)

Where standard Type 6 Timber Frame Ties are unsuitable, our recommendation is the use of the Timber Frame Movement Tie. Manufactured to suit any cavity from 50mm to 150mm, the Ancon Timber Frame Movement Tie comprises a channel, a strip tie and a screw. This system accommodates maximum differential movement of 60mm; the tie should be positioned 15mm from the bottom of the channel. The tie is suitable for use with the Universal Insulation Clip.

The TFMT complies with BS 5268-6.1 as a Type 7 tie. The product has a declared value of 970N. See page 7 for more information on Type 7 ties.

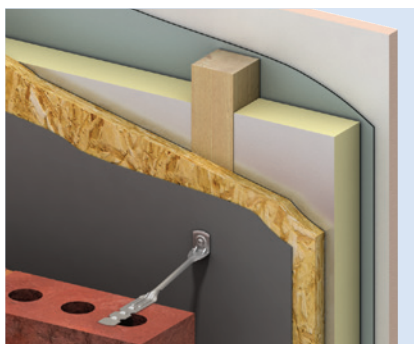

Ancon Staifix STF6 Timber Frame Tie  
Available to suit 50mm, 75mm and 100mm cavities.

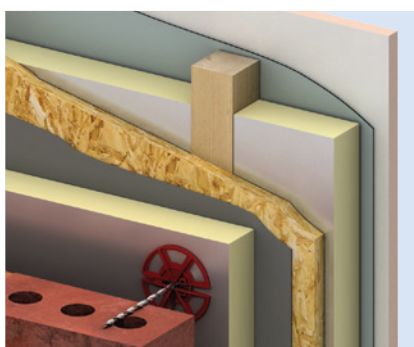

Ancon Staifix-Thor Helical TIM6 Tie

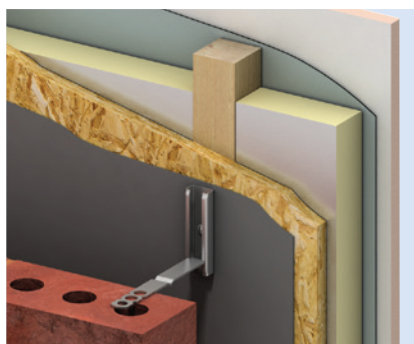

Ancon TFMT7 Timber Frame Movement Tie

### Ancon Teplo-L-Tie (Type 6)

The Teplo-L-Tie is ideal where a low thermal conductivity restraint fixing is required between a masonry outer leaf and an in-situ timber frame. The body is manufactured from basalt fibres set in a resin matrix and features a stainless steel upstand at one end with a 7mm diameter fixing hole. When fixing to timber, we recommend a 5mm x 30mm countersunk wood screw.

This tie is suitable for cavities from 100mm to 300mm, features a moveable o-ring drip to prevent water crossing the cavity and can be used with the black Teplo-Clip where insulation is to be retained.

The Teplo-L-Tie has been independently tested, is approved by the BBA and can be used in line with NHBC standards.



A Lambda value (W/mK) is normally given for Ancon wall ties which expresses the thermal conductivity of the material i.e. 17W/mK for stainless steel ties and 0.7W/mK for basalt fibre Teplo ties, however, as the Teplo-L-Tie comprises both materials a Lambda value is not applicable. Instead, to aid with U-value calculations, the table below provides the Chi value of an individual Teplo-L-Tie and the U-value correction ( $\Delta U_f$ ) if Teplo-L-Ties were installed at the standard 4.4 ties per square metre. BS EN ISO 6946 permits the corrections due to wall ties and air gaps between insulation boards etc, to be omitted from U-value calculations if the corrections amount to less than 3% of the uncorrected U-value of the element.

The Teplo-L-Tie is suitable for fixing to a range of substrates. For more information, see page 17.

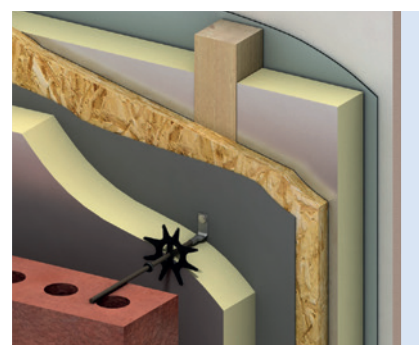

Ancon Teplo-L-Tie (Type 6)

#### Teplo-L-Tie Type 6 Range and Chi Values

Product Code	Length mm	Cavity mm	BS5268 Type	Chi-value W/K	$\Delta U_f$ (if 4.4 ties/m <sup>2</sup> ) W/m <sup>2</sup> K
TEPLO-L-5-165	165	100	6	0.000335	0.00147
TEPLO-L-5-190	190	125	6	0.000260	0.00114
TEPLO-L-5-215	215	150	6	0.000215	0.00095
TEPLO-L-5-240	240	175	6	0.000175	0.00077
TEPLO-L-5-265	265	200	6	0.000150	0.00066
TEPLO-L-7-290	290	225	6	0.000210	0.00092
TEPLO-L-7-315	315	250	6	0.000190	0.00084
TEPLO-L-7-340	340	275	6	0.000165	0.00073
TEPLO-L-7-365	365	300	6	0.000150	0.00066

# Wall Ties and Restraint Fixings

## Frame Cramps

Frame cramps are an ideal solution where a restraint is required between masonry and in-situ structures. They can be fixed to a range of materials including concrete, steelwork and masonry. Frame cramps referenced **\_P\_** have a plain shank, while those referenced **\_D\_** feature an integral drip for use across a cavity.

### Ancon SDB

Ancon SDB Frame Cramps used as cavity wall ties exceed the requirements of a Type 2 tie to PD 6697: 2019 for lengths up to 450mm. They have a 7mm diameter hole to suit a range of fixings. Ancon M6 expansion bolts are recommended for fixing to concrete and M6 set screws or SDTSS-38-5PT self-drilling screws for fixing to steelwork. Frame cramps can be fixed to masonry with suitable plugs and screws or resin anchors. Poor substrates will limit the capacity of fixings and site testing is advisable in such applications. All fixings should be used in conjunction with a DIN washer.

### Ancon SDV

Ancon SDV Frame Cramps have an 8mm x 30mm vertical slot that allows vertical fixing position adjustment where required. Their load capacity is limited when fixed in the top of the slot therefore they are not recommended for applications where tension is a consideration.

### Ancon HiT - Hammer-in Tie

The Ancon HiT fixes masonry to dense blocks ( $\geq 7\text{N/mm}^2$ ), non-perforated brick or hard stone. It can reduce the variety of tie lengths required on site and speed the rate of construction.

The HiT is available in a standard length of 310mm that is bent on site with a special installation tool to suit all cavities up to 150mm. Unlike conventional frame cramps it does not require a mechanical fixing, but is hammered into a plug.

The Ancon HiT meets the requirements of PD 6697: 2019 as a Type 2 tie. A neoprene 'O' ring must be installed on the tie to prevent moisture crossing the cavity.



Ancon Hammer-in Tie (310mm)

## Recommended Tie Lengths and Fixing Centres for SDB Frame Cramps

Cavity Width (mm)	Length of Wall Tie (mm)	Recommended Spacing (mm)		Cavity Width (mm)	Length of Wall Tie (mm)	Recommended Spacing (mm)	
		Type 1	Type 2			SDB-T1	SDB-T2
20-44*	100	600 x 450	900 x 450	245-269	325	900 x 450	900 x 450
45-69	125	600 x 450	900 x 450	270-294	350	900 x 450	900 x 450
70-94	150	600 x 450	900 x 450	295-319	375	900 x 450	900 x 450
95-119	175	900 x 450	900 x 450	320-344	400	900 x 450	900 x 450
120-144	200	900 x 450	900 x 450	345-369	425	900 x 450	900 x 450
145-169	225	900 x 450	900 x 450	370-394	450	900 x 450	900 x 450
170-194	250	900 x 450	900 x 450				
195-219	275	900 x 450	900 x 450				
220-244	300	900 x 450	900 x 450				

**Note:** \*Due to limited length of tie a water drip would not be provided. Centres shown achieve equivalent tie type performances to PD 6697: 2019. See page 7 for details.

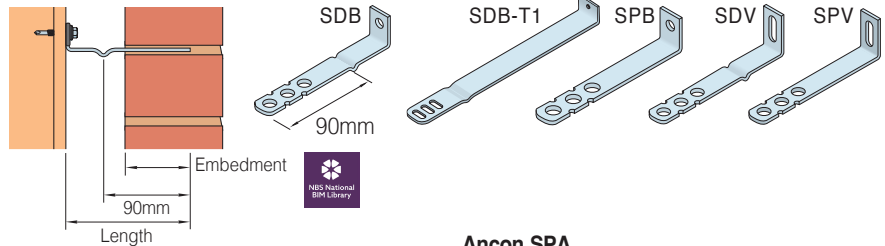

### SDB Frame Cramp Fixed to Steel with Self-Drilling Screw

#### Isolation

Ancon isolation sleeves and pads are supplied blank for use with self-drilling screws to isolate stainless steel frame cramps from mild steel. Self-adhesive isolation pads are also available for **\_B\_** (20 x 30mm) and **\_V\_** (25 x 50mm) referenced frame cramps, up to 300mm long.

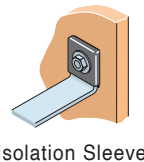

Isolation Sleeve

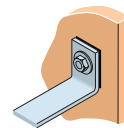

Adhesive Isolation Pad

#### Thermal Breaks

Ancon Frame Cramps can be supplied with Thermal Breaks to be located between the upstand and the structural frame to reduce thermal bridging across an insulated cavity.

They have a thermal conductivity of just 0.3 W/mK.

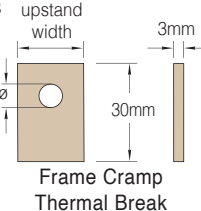

Frame Cramp Thermal Break

### Ancon SPA

Where masonry is in line with a column flange, a notched wall tie is used in conjunction with a bespoke angle section to allow the mechanical fixing to be suitably located. This system is referenced SPA. The angle section features a 7mm fixing hole as standard and a slot to accept the wall tie. The slot provides vertical tolerance in the position of the tie allowing the angles to be fixed in advance of the masonry if required. Ties can be used with debonding sleeves when used at vertical movement joints. The thickness, size and shape of the angle are designed to suit each application. Contact our Technical Department or download the online design sheet.

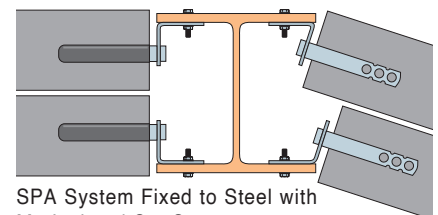
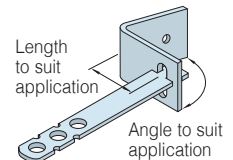

SPA System Fixed to Steel with M6 Isolated Set Screws

### Pre-Fixing Aids

The practice of pre-fixing frame cramps in advance of masonry can accelerate the speed of construction and provides an opportunity to check that wall restraints have been located correctly and are securely fixed.

#### Ancon Gauge Tape (Pre-fix Patent 2 256 223)

Gauge Tape illustrates the standard 225mm brick/block gauge and the fixing position of frame cramps. It is applied directly to the structural frame (steel, concrete, timber or masonry) to facilitate the pre-fixing of frame cramps and to maintain accurate masonry coursing.

### Ancon ISO-TW Washer

The ISO-TW washer enables Ancon slot-ended frame cramps to be vertically adjusted within the 30mm range of the slot to suit the exact location of mortar joints without affecting the integrity of the fixing. In addition, this washer prevents bi-metallic corrosion by separating the frame cramp from the structural frame and fixing screw.

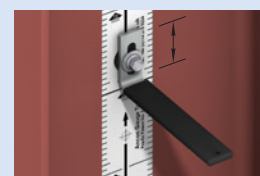

Ancon ISO-TW Washer and Gauge Tape



## Teplo-L-Tie

The Teplo-L-Tie is ideal where a low thermal conductivity restraint fixing is required between a masonry outer leaf and an in-situ structure. It offers the same thermal benefit as Teplo basalt fibre cavity wall ties (page 11), with an additional stainless steel upstand which is mechanically and chemically bonded to one end of the tie to allow for a secondary fixing.

The 7mm diameter hole in the upstand suits a variety of fixings, typically an M6 expansion bolt for concrete, a plug and screw for either masonry or concrete, and either an M6 set screw or SDTSS-38-5PT self-drilling screw for steelwork. The load performance will depend on the substrate and on-site pull out tests are recommended to confirm the strength of uncertain or old substrates. For fixing to timber frames, see page 15.

Teplo-L-Ties are suitable for cavities from 100mm to 300mm. The range comprises 14 standard products which meet the performance of Tie Types 2, 3 or 4 when installed at a standard spacing of 2.5 ties per square metre; decreasing wall tie centres can increase the performance level as shown in the table.

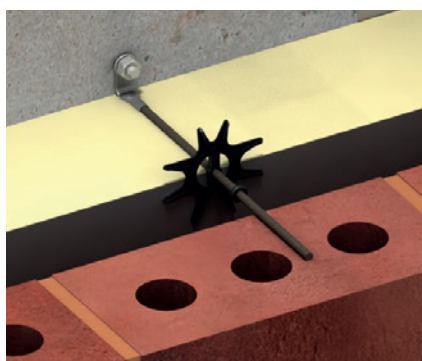

Teplo-L-Tie can be fixed to concrete, masonry, steel and timber

An o-ring drip prevents water crossing the cavity and the Teplo-L-Tie can be used with the black Teplo-Clip where insulation is to be retained.

A Lambda value (W/mK) is normally given for Ancon wall ties which expresses the thermal conductivity of the material i.e. 17W/mK for stainless steel ties and 0.7W/mK for basalt fibre Teplo ties, however, as the Teplo-L-Tie comprises both materials a Lambda value is not applicable. Instead, to aid with U-value calculations, the table provides the Chi value of an individual Teplo-L-Tie and the U-value correction ( $\Delta U_i$ ) if Teplo-L-Ties were installed at the standard spacing of 2.5 ties per square metre (900mm x 450mm centres). BS EN ISO 6946 permits the corrections due to wall ties and air gaps between insulation boards etc, to be omitted from U-value calculations if the corrections amount to less than 3% of the uncorrected U-value of the element.

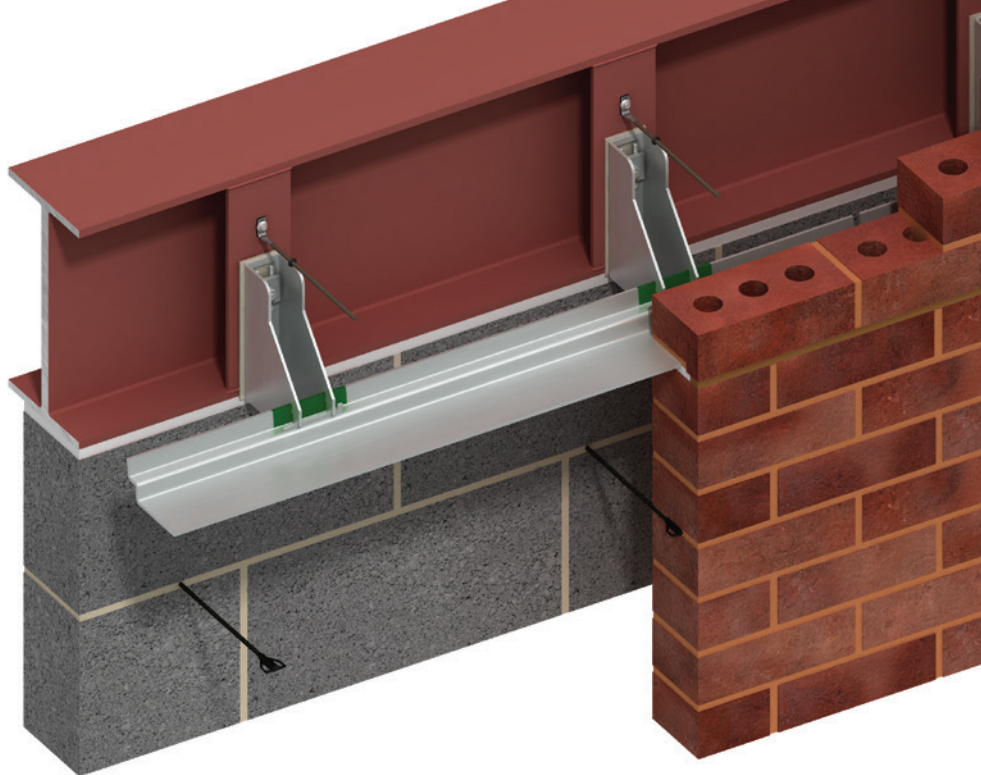

Teplo-BF cavity wall ties and Teplo-L-Tie frame cramps used with an Ancon stainless steel brick support system featuring a thermal break



The BBA-approved Teplo-L-Tie is available to suit cavities from 100mm to 300mm



## Teplo-L-Tie Product Codes and Recommended Fixing Centres

Product Code	PD 6697 Tie Type	Cavity mm	Tie Length mm	Recommended Spacing (mm)			
				Type 1*	Type 2	Type 3	Type 4
TEPLO-L-7-165	2	100	165	500 X 450	900 X 450	-	-
TEPLO-L-7-190	2	125	190	500 X 450	900 X 450	-	-
TEPLO-L-7-215	2	150	215	500 X 450	900 X 450	-	-
TEPLO-L-7-240	2	175	240	500 X 450	900 X 450	-	-
TEPLO-L-7-265	2	200	265	500 X 450	900 X 450	-	-
TEPLO-L-7-290	2	225	290	500 X 450	900 X 450	-	-
TEPLO-L-7-315	2	250	315	500 X 450	900 X 450	-	-
TEPLO-L-7-340	2	275	340	500 X 450	900 X 450	-	-
TEPLO-L-7-365	2	300	365	500 X 450	900 X 450	-	-
TEPLO-L-5-165	3	100	165	380 X 450	710 X 450	900 X 450	-
TEPLO-L-5-190	3	125	190	380 X 450	710 X 450	900 X 450	-
TEPLO-L-5-215	3	150	215	380 X 450	710 X 450	900 X 450	-
TEPLO-L-5-240	4	175	240	230 X 450	450 X 450	740 X 450	900 X 450
TEPLO-L-5-265	4	200	265	230 X 450	450 X 450	740 X 450	900 X 450

**Note:** Centres shown achieve equivalent tie type performances to PD 6697: 2019; Table 12. See page 7 for details. \*Type 1 based on M2 mortar and a strength requirement of 2500N (PD 6697: 2019) in Tension and Compression.

## Teplo-L-Tie Chi Values

Product Code	Tie Length mm	PD 6697 Tie Type	Chi value W/K	$\Delta U_i$ (if 2.5 ties/m <sup>2</sup> ) W/m <sup>2</sup> K
TEPLO-L-7-165	165	2	0.000515	0.00129
TEPLO-L-7-190	190	2	0.000405	0.00101
TEPLO-L-7-215	215	2	0.000340	0.00085
TEPLO-L-7-240	240	2	0.000280	0.00070
TEPLO-L-7-265	265	2	0.000245	0.00061
TEPLO-L-7-290	290	2	0.000210	0.00053
TEPLO-L-7-315	315	2	0.000190	0.00048
TEPLO-L-7-340	340	2	0.000165	0.00041
TEPLO-L-7-365	365	2	0.000150	0.00038
TEPLO-L-5-165	165	3	0.000335	0.00084
TEPLO-L-5-190	190	3	0.000260	0.00065
TEPLO-L-5-215	215	3	0.000215	0.00054
TEPLO-L-5-240	240	4	0.000175	0.00044
TEPLO-L-5-265	265	4	0.000150	0.00038

# Wall Ties and Restraint Fixings

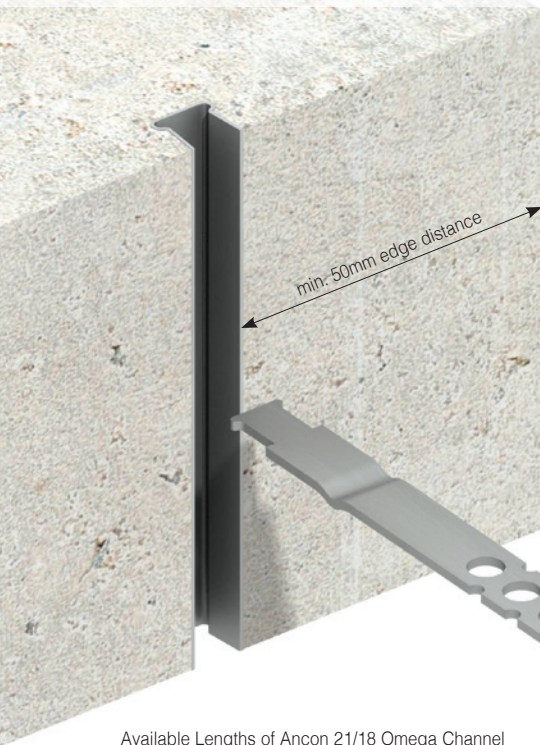

## Channel Ties

### Ancon 21/18 Omega Channel

Ancon 21/18 Omega Channel is a high performance, self-anchoring, cast-in channel slot suitable for use with Ancon wall ties to provide the necessary restraint to the outer leaf of masonry. The section is only 18mm deep and can be used where there is reduced cover to reinforcement and concrete as thin as 75mm. Available in 100mm and 3000mm lengths, Ancon 21/18 Omega Channel is filled with polystyrene to help prevent the ingress of concrete. Nail holes aid the fixing of the slot to timber formwork.

### Ancon 25/14, 28/15, 30/20, 38/17, 36/8 and 40/25 Channels

Ancon wall ties can also be used with our 25/14, 28/15, 30/20, 38/17, 36/8 and 40/25 channels.

30/20 Channel is supplied with anchors for casting into concrete. 25/14 and 36/8 Channels are supplied plain-backed for surface fixing. 28/15, 38/17 and 40/25 Channels are available with or without anchors for casting in or surface fixing. Data shown below applies to cavity wall ties into 21/18, 28/15, 30/20, 38/17 and 40/25 cast-in channels. 36/8 channels are only suitable for shear applications, see pages 20 and 29. For 25/14 channels see page 13. Maximum safe working loads of surface-fixed channels will be subject to suitable fixings, and appropriate fixing centres. Consult our Technical Department for advice.

Available Lengths of Ancon 21/18 Omega Channel  
**100, 3000mm**

Ancon 21/18 Omega Channel with Ancon SD21 Tie



## Recommended Tie Spacing for Cast-in Channel Stainless Steel Ties for Masonry Cavity Applications

Tie Length (mm)	Cavity Width (mm)	Type 1	Type 2
125	45-69	600x450	900x450
150	70-94	600x450	900x450
175	95-119	750x450	900x450
200	120-144	750x450	900x450
225	145-169	750x450	900x450
250	170-194	750x450	900x450
275	195-219	750x450	900x450
300	220-244	300x450	600x450

**Note:** Centres shown achieve equivalent tie type performances to PD 6697: 2019. See page 7 for details.

## Fixing of Channel

Fixing Method	Omega 21/18	25/14	28/15	30/20	38/17	36/8	40/25
Cast-in	✓	✗	✓	✓	✓	✗	✓
Surface Fixed	✗	✓	✓	✗	✓	✓	✓

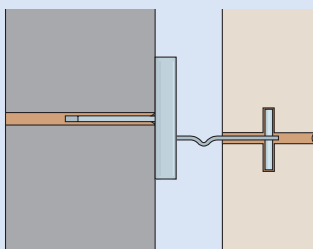

Fastrack used with DD28 Tie for Stonework

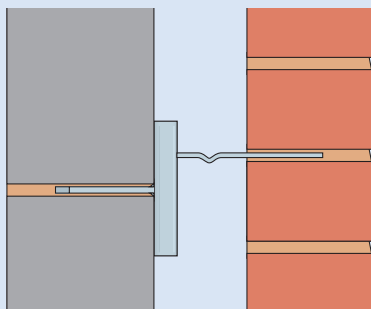

Fastrack used with SD28 Tie for Brickwork

## Ancon Fastrack

Building one leaf of the cavity wall in advance of the other is often beneficial but can create problems with coursing. Buildings which incorporate imperial or continental bricks and standard metric blocks present even greater difficulties.

Ancon Fastrack Channel is built into the inner leaf of blockwork ready to take an Ancon SD28 or similar tie for the outer leaf. This method of construction avoids the dangers of projecting ties.

Ancon Fastrack Channels and Ties suit cavities from 50mm to 250mm and can also be used for tying stonework to blockwork if DD28 or similar Ancon Ties are used.

**The recommended tie length for use with a fastrack channel is 'cavity width plus 50mm'.**

Tie Reference	Type 1	Type 2	Type 3	Type 4
28/15 Fastrack	450x450	900x450	900x450	900x450
36/8 Fastrack	450x450	900x450	900x450	900x450

**Note:** Centres shown achieve equivalent tie type performances to PD 6697: 2019. See page 7 for details.

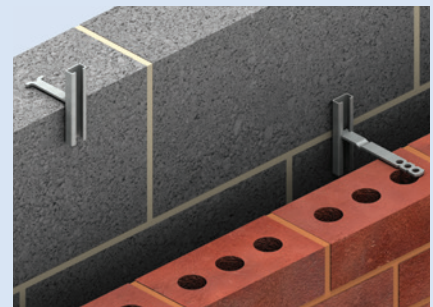

Ancon Fastrack Channels 100mm long with SD28 Tie

Ancon 28/15 Fastrack Channels and Ties sustain loads which exceed the requirements for a Type 2 tie to PD 6697: 2019. This system can also be manufactured in a 36/8 channel which also offers Type 2 performance and accepts wall ties referenced \_\_ 36.

## Teplo-Channel Ties

The Ancon Teplo-Channel tie range has been specifically designed to provide a low thermal conductivity wall tie for use with our popular Omega 21/18, 25/14 and 28/15 channel profiles. Ancon Teplo-Channel ties provide unlimited adjustment along the length of the channel and are ideal for use with SFS and concrete frames.

The tie body uses the same combination of basalt fibres set in a resin matrix as the Teplo cavity wall tie and has a moulded safety end for building into the outer leaf bed joint. On the opposite end is a profiled stainless steel head which is shaped to suit each individual channel and is mechanically fixed in place.

Teplo-Channel ties are suitable for cavities from 70mm to 344mm and meet the performance of Tie Types 1, 2 or 3 depending on tie spacing; please see data table for more information. The unique ribbed shank

acts as a drip and prevents water crossing the cavity. Where insulation is to be retained, the black Teplo-Clip can be used and is compatible with the full range of Teplo-Channel ties.

A Lambda value (W/mK) is normally given for Ancon wall ties which expresses the thermal conductivity of the material i.e. 17W/mK for stainless steel ties and 0.7W/mK for basalt fibre Teplo ties. However, as the Teplo-Channel ties comprise both materials, a Lambda value is not applicable. Instead, to aid with U-value calculations, the tables provide the Chi value of the individual Teplo-Channel ties and the U-value correction ( $\Delta U_f$ ) if Teplo-Channel ties were installed at the standard spacing of 2.5 ties per square metre (900mm x 450mm centres). For Teplo-BF-CT 25 ties (for use with the Ancon 25/14 system) a standard tie spacing of 3.7 ties per square metre is used (600mm x 450mm centres).

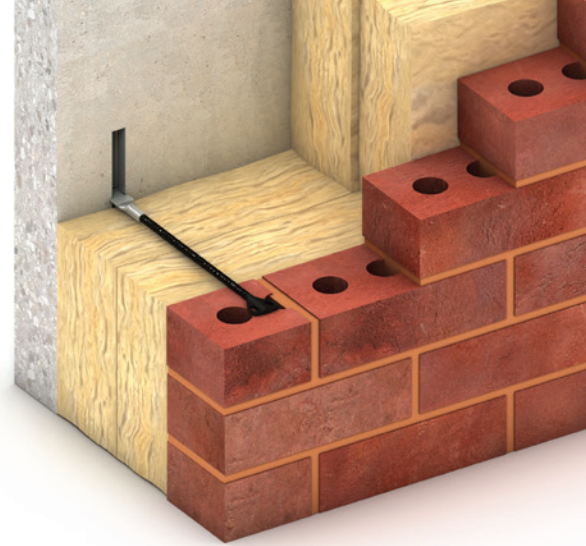

BS EN ISO 6946 permits the corrections due to wall ties and air gaps between insulation boards etc., to be omitted from U-value calculations if the corrections amount to less than 3% of the uncorrected U-value of the element.

The Teplo-Channel tie range has been independently tested and is BBA approved; a British Board of Agrément certificate is available to download online.

### Ancon Teplo-Channel Tie Chi Values

Product Code	Tie Length (mm)	PD 6697 Tie Type	Chi value (W/K)	$\Delta U_f$ 2.5 ties/m <sup>2</sup> (W/m <sup>2</sup> K)
Teplo-BF-CT 21 - 150	150	2	0.0009	0.00225
Teplo-BF-CT 21 - 175	175	2	0.0006	0.00150
Teplo-BF-CT 21 - 200	200	2	0.0004	0.00100
Teplo-BF-CT 21 - 225	225	2	0.0003	0.00075
Teplo-BF-CT 21 - 250	250	2	0.0003	0.00075
Teplo-BF-CT 21 - 275	275	2	0.0002	0.00050
Teplo-BF-CT 21 - 300	300	2	0.0002	0.00050
Teplo-BF-CT 21 - 325	325	3	0.0002	0.00050
Teplo-BF-CT 21 - 350	350	3	0.0001	0.00025
Teplo-BF-CT 21 - 375	375	3	0.0001	0.00025
Teplo-BF-CT 28 - 150	150	2	0.0009	0.00225
Teplo-BF-CT 28 - 175	175	2	0.0006	0.00150
Teplo-BF-CT 28 - 200	200	2	0.0004	0.00100
Teplo-BF-CT 28 - 225	225	2	0.0003	0.00075
Teplo-BF-CT 28 - 250	250	2	0.0003	0.00075
Teplo-BF-CT 28 - 275	275	2	0.0002	0.00050
Teplo-BF-CT 28 - 300	300	2	0.0002	0.00050
Teplo-BF-CT 28 - 325	325	3	0.0002	0.00050
Teplo-BF-CT 28 - 350	350	3	0.0001	0.00025
Teplo-BF-CT 28 - 375	375	3	0.0001	0.00025
Teplo-BF-CT 28 - 400	400	3	0.0001	0.00025

Data based on thermal modelling using mineral wool in a full fill cavity with channel cast into concrete and Teplo-BF-CT ties bridging the insulation zone.

**Note:** Thermal values will vary for other wall build-ups. For more information please contact Leviat.

Product Code	Tie Length (mm)	PD 6697 Tie Type	Chi value (W/K)	$\Delta U_f$ 3.7 ties/m <sup>2</sup> (W/m <sup>2</sup> K)
Teplo-BF-CT 25 - 150	150	2	0.0008	0.00289
Teplo-BF-CT 25 - 175	175	2	0.0007	0.00250
Teplo-BF-CT 25 - 200	200	2	0.0006	0.00216
Teplo-BF-CT 25 - 225	225	2	0.0005	0.00191
Teplo-BF-CT 25 - 250	250	2	0.0005	0.00167
Teplo-BF-CT 25 - 275	275	2	0.0004	0.00150
Teplo-BF-CT 25 - 300	300	3	0.0004	0.00133
Teplo-BF-CT 25 - 325	325	3	0.0003	0.00122
Teplo-BF-CT 25 - 350	350	3	0.0003	0.00109
Teplo-BF-CT 25 - 375	375	3	0.0003	0.00100

Data based on thermal modelling using 100mm thick mineral wool in a partial fill cavity with channel fixed to front of insulation and Teplo-BF-CT ties bridging the remaining clear cavity.

**Note:** Thermal values will vary for other wall build-ups. For more information please contact Leviat.

### Ancon Teplo-Channel Tie Product Codes and Recommended Fixing Centres

Product Code	PD 6697 Tie Type	Cavity Range (mm)	Tie Length (mm)	Recommended Spacing (mm)	
				Type 1*	Type 2
Teplo-BF-CT 21 - 150	2	70 - 94	150	600x375	600x450
Teplo-BF-CT 21 - 175	2	95 - 119	175	600x375	600x450
Teplo-BF-CT 21 - 200	2	120 - 144	200	600x375	600x450
Teplo-BF-CT 21 - 225	2	145 - 169	225	600x375	600x450
Teplo-BF-CT 21 - 250	2	170 - 194	250	600x375	600x450
Teplo-BF-CT 21 - 275	2	195 - 219	275	600x375	600x450
Teplo-BF-CT 21 - 300	2	220 - 244	300	600x375	600x450
Teplo-BF-CT 21 - 325	3	245 - 269	325	600x225	600x450
Teplo-BF-CT 21 - 350	3	270 - 294	350	600x225	600x450
Teplo-BF-CT 21 - 375	3	295 - 319	375	600x225	600x450
Teplo-BF-CT 25 - 150	2	85 - 109	150	600x300	600x450
Teplo-BF-CT 25 - 175	2	110 - 134	175	600x300	600x450
Teplo-BF-CT 25 - 200	2	135 - 159	200	600x300	600x450
Teplo-BF-CT 25 - 225	2	160 - 184	225	600x300	600x450
Teplo-BF-CT 25 - 250	2	185 - 209	250	600x300	600x450
Teplo-BF-CT 25 - 275	2	210 - 234	275	600x300	600x450
Teplo-BF-CT 25 - 300	3	235 - 259	300	600x225	600x450
Teplo-BF-CT 25 - 325	3	260 - 284	325	600x225	600x450
Teplo-BF-CT 25 - 350	3	285 - 309	350	600x225	600x450
Teplo-BF-CT 25 - 375	3	310 - 334	375	600x225	600x450
Teplo-BF-CT 28 - 150	2	70 - 94	150	600x375	600x450
Teplo-BF-CT 28 - 175	2	95 - 119	175	600x375	600x450
Teplo-BF-CT 28 - 200	2	120 - 144	200	600x375	600x450
Teplo-BF-CT 28 - 225	2	145 - 169	225	600x375	600x450
Teplo-BF-CT 28 - 250	2	170 - 194	250	600x375	600x450
Teplo-BF-CT 28 - 275	2	195 - 219	275	600x375	600x450
Teplo-BF-CT 28 - 300	2	220 - 244	300	600x375	600x450
Teplo-BF-CT 28 - 325	3	245 - 269	325	600x225	600x450
Teplo-BF-CT 28 - 350	3	270 - 294	350	600x225	600x450
Teplo-BF-CT 28 - 375	3	295 - 319	375	600x225	600x450
Teplo-BF-CT 28 - 400	3	320 - 344	400	600x225	600x450

**Note:** Centres shown achieve equivalent tie type performances to PD 6697:2019 Table 12. See page 7 for details.

\*Type 1 based on M2 mortar and 2500N Tensile/ 2000N Compressive capacity (PD 6697:2019). Cavity range values refer to cast-in applications for 21 and 28 ends. For surface-fixed 28/15 applications, cavity values should be increased by 15mm. Cavity range values given for 25 ends refer to channels fixed to front of insulation i.e. remaining clear cavity.

# Wall Ties and Restraint Fixings

## Vertical Movement Joints

Debonding sleeves are used on plain-ended wall ties, such as the Ancon PP21 or PPB, at vertical movement joints that abut columns. The tie will restrain the masonry against lateral wind loads whilst the sleeve allows the masonry to expand and contract.

These shear ties are available either to suit cast-in channels or as frame cramps to be post-fixed on site. Channel ties are available to suit Ancon 21/18, 28/15, 30/20, 36/8, 38/17 and 40/25 channels. Frame cramps are available as a PPB with a single hole or as a PPV with a vertical slot. PPS ties are used across movement joints in masonry walls. PPB-HD is a heavy duty version of the PPB.

These ties are subject to shear rather than tensile / compressive forces and can be selected from the following table. The design resistances shown should be used with factored wind loads.

Ancon shear ties are suitable for a standard 10mm joint and require a minimum embedment of 100mm. Debonding sleeves should be installed with a 10mm gap at the end to allow for expansion of the masonry. The ties are also available with a bonded safety end for applications where a debonding sleeve is not required.

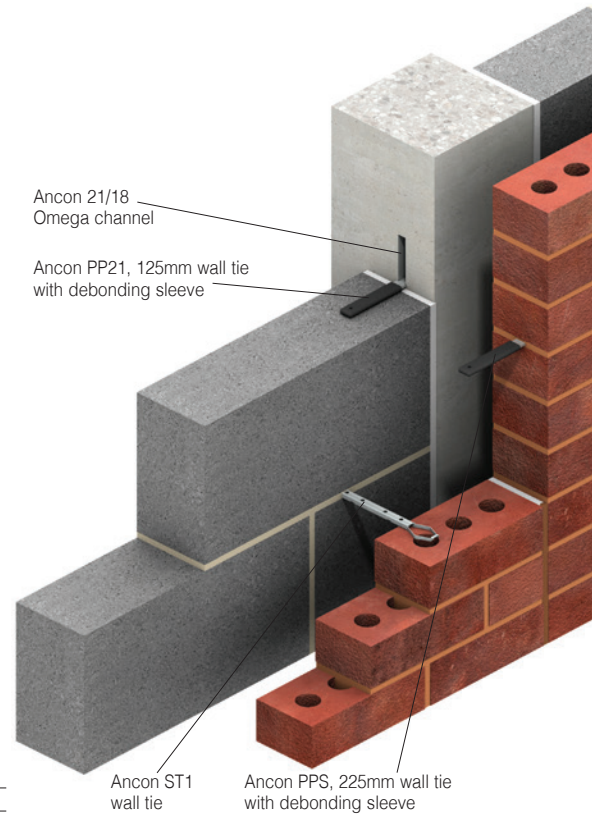

Intermediate Column with Vertical Movement Joint in Brickwork and Blockwork

## Design Resistances for Shear Ties

Tie	Design Resistance (N)	Design Resistance per metre (N/m)	
		450mm centres	225mm centres
Channel Ties	900	2000	4000
PPV	463	1028	2056
PPB	663	1474	2948
PPB-HD	896	1991	3982
PPS	896	1991	3982

**Note:** Design resistances shown use a material factor,  $\gamma_m$  of 3.0 as given in the UK National Annex to BS EN 1996-1-1:2005

Ancon PPS Wall Tie with Debonding Sleeve  
175, 225, 250, 275, 300mm

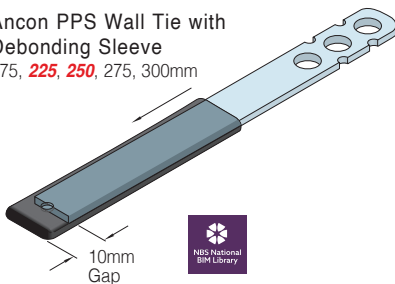

Debonding sleeves should be pulled back 10mm to allow expansion as well as contraction of brickwork

Ancon PPB Wall Tie with Debonding Sleeve  
Lengths 125, 150, 175, 200, 225mm

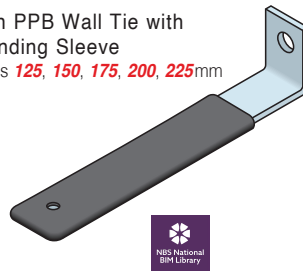

Ancon PPV Wall Tie with Debonding Sleeve  
Lengths 125, 150, 175, 200, 225mm



Ancon ST1 wall tie

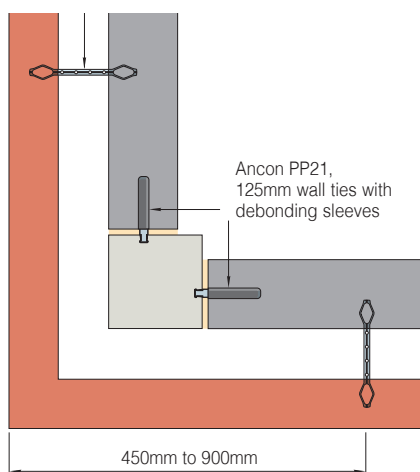

External Corner with Fully Bonded Brickwork

Ancon PP21, 125mm wall ties with debonding sleeves

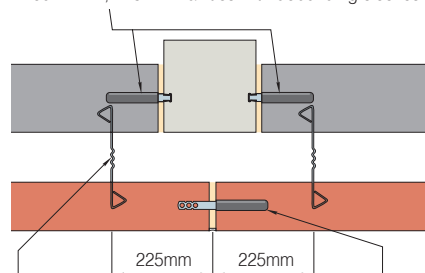

Ancon Staifix RT2 wall ties at 450mm vertical centres in alternate courses to PPS ties  
Ancon PPS, 225mm wall ties with debonding sleeves, at 450mm vertical centres

Intermediate Column with Vertical Movement Joints in both Brickwork and Blockwork

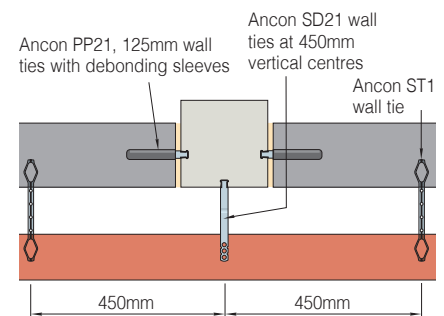

Intermediate Column with Vertical Movement Joints in Blockwork

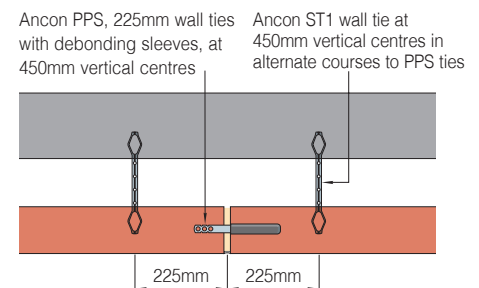

Cavity Wall with Vertical Movement Joint in Brickwork

**Note:** All spacings are maximums. The type of cavity wall tie and spacing will be determined by the cavity width, height of brickwork, wind loading and type of building. See page 7 for further information.

## Standard Wall Ties

Lengths shown in **red italics** refer to items normally available at all times.

Our Technical Services Team will be pleased to advise on the correct selection and use of our wall ties.

### ST1

Lengths **200, 225, 250, 275, 300, 325, 350**mm  
Conforms to PD 6697: 2019 as a Type 1 tie in M2 mortar

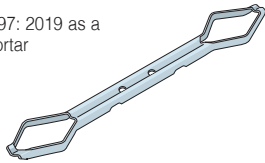

### DT (Double Triangle)

Lengths **150\*, 200\*, 225\*, 250\*\*, 300\*\***mm  
\*Conforms to EN 845-1 and PD 6697: 2019 as a Type 2 tie  
\*\*Conforms to EN 845-1 and PD 6697: 2019 as a Type 3 tie

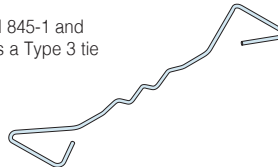

### SPS

Lengths **150, 200, 225, 250, 275, 300**mm  
(Not suitable for collar-jointed construction. See below)

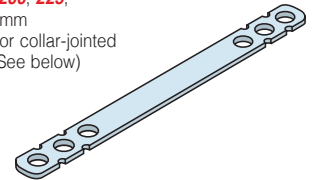

### Teplo-BF1

Lengths **200, 225, 250, 275**mm  
Conforms to PD 6697: 2019 as a Type 1 tie.

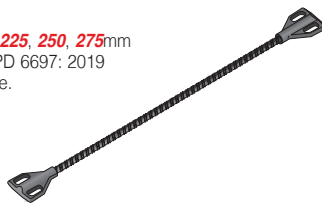

### RD3

Lengths **250, 275**mm  
Conforms to PD 6697: 2019 as a Type 3 tie

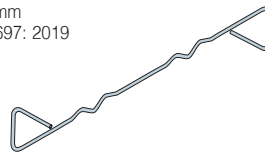

### SPS CJ

Length **150**mm  
(3mm thickness for collar-jointed construction)

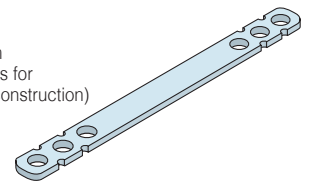

### SDS

Lengths **200, 225, 250, 275, 300**mm  
Conforms to PD 6697: 2019 as a Type 1 tie in M2 (iv) mortar.  
Also available with a central drip

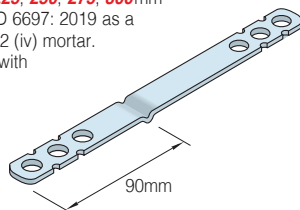

### HRT4

Lengths **200, 225, 250, 275**mm  
Conforms to PD 6697: 2019 as a Type 4 tie



Suitable for party walls with 50-100mm and 125-150mm cavities

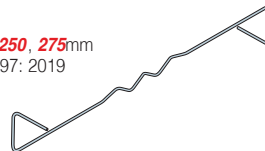

### PPS

Lengths **175, 225, 250, 275, 300**mm

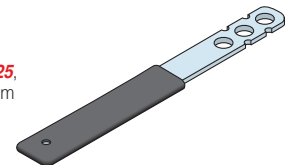

### SDS-T1, SDS-T2

Lengths **325, 350, 375, 400, 425, 450, 475, 500, 525**mm  
Conforms to PD 6697: 2019 as a Type 1 tie in M2 (iv) mortar.  
Also available with a central drip

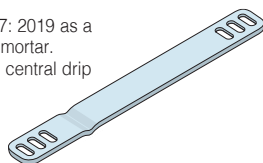

### HRD4

Lengths **250, 275**mm  
Conforms to PD 6697: 2019 as a Type 4 tie

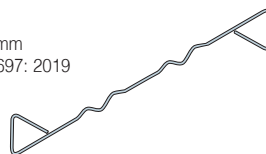

### SHX

Lengths 150, 175, 200, 225mm

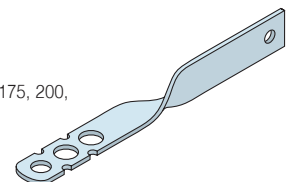

### RT2

Lengths **200, 225, 250, 275**mm  
Conforms to PD 6697: 2019 as a Type 2 tie

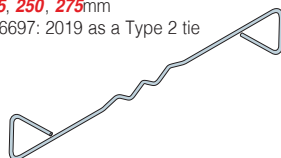

### Teplo-BF4

Lengths **200, 225, 250, 550, 575**mm  
Conforms to PD 6697: 2019 as a Type 4 tie



### SRB

Lengths **125, 150, 175, 200, 300**mm  
(Used in applications instead of the SDB where greater flexibility is required)

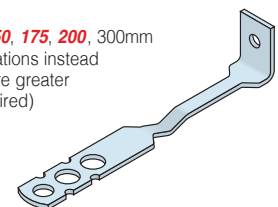

### Teplo-BF2

Lengths **200, 225, 250, 275, 300, 325, 350, 375, 400, 425**mm  
Conforms to PD 6697: 2019 as a Type 2 tie

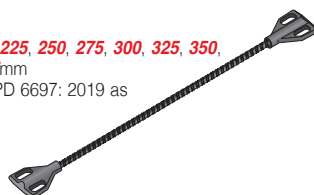

### Recommended Lengths for Masonry/Masonry Wall Ties

Cavity Width (mm)	Tie Length (mm)	Cavity Width (mm)	Tie Length (mm)
50-75	200	251-275	400
76-100	225	276-300	425
101-125	250	301-325	450
126-150	275	326-350	475
151-175	300	351-375	500
176-200	325	376-400	525
201-225	350	401-425	550
226-250	375	426-450	575

# Wall Ties and Restraint Fixings

## Standard Wall Ties

Lengths shown in **red italics** refer to items normally available at all times.

Our Technical Services Team will be pleased to advise on the correct selection and use of our wall ties.

### SPB

Lengths 75, **100, 125, 150**, 175, **200**, 225, 250, 275, 300mm  
(Heavy duty version also available)

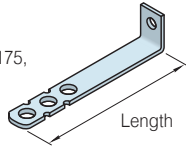

### SPV

Lengths 75, **100, 125, 150**, **175, 200**, 225, 250, 275, 300mm

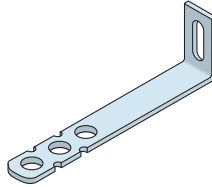

### Cavity Starter Tie

Supplied with an 8mm nylon wall plug and neoprene ring  
Lengths **180, 200, 230**mm

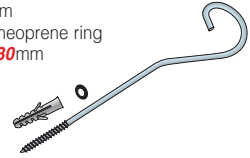

### SDB

Lengths **125, 150, 175, 200, 225**, 250, 275, 300, 325, 350, 375, 400, 425, 450mm

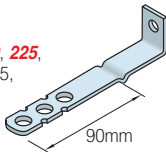

### SDV

Lengths **125, 150**, **175, 200**, 225, 250, 275, 300mm

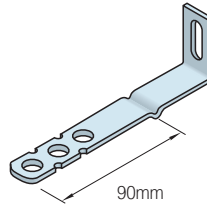

### Starter Tie

Supplied with an 8mm nylon wall plug  
Length **135**mm

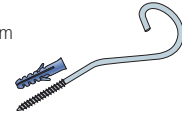

### SDB-T1, SDB-T2

Lengths 325, 350, 375, 400, 425, 450mm

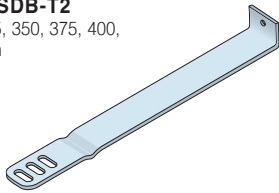

### PPV

Lengths **125, 150, 175, 200**, 225mm

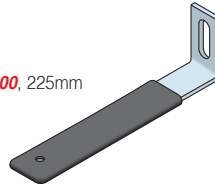

### Frame Tie

Length **115**mm

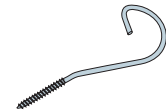

### Teplo-L-Tie

Lengths 165, 190, 215, 240, 265, 290, 315, 340, 365mm  
(See page 15 and 17)

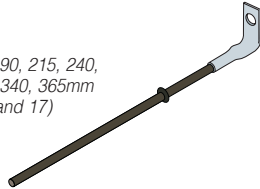

### SP21

Lengths **75, 100, 125, 150**, **175, 200**mm  
For use with 21/18 Omega Channel  
\*see Channels, Bolts and Fixings brochure for more information

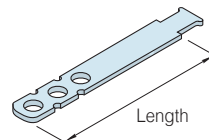

### Teplo-BF-CT

21 and 25 ends: Lengths 150, 175, 200, 225, 250, 275, 300, 325, 350, 375mm  
28 ends: Lengths 150, 175, 200, 225, 250, 275, 300, 325, 350, 375, 400mm

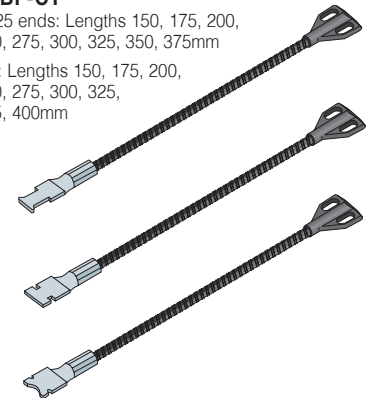

### PPB

Lengths **125, 150, 175**, **200, 225**mm

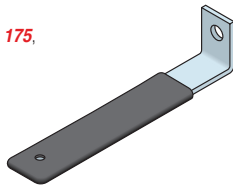

### SD21

Lengths **125, 150, 175, 200**, 225, 250, 275, 300mm  
For use with 21/18 Omega Channel  
\*see Channels, Bolts and Fixings brochure for more information

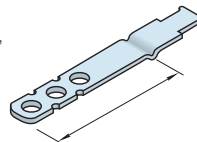

### PP21

Lengths **125, 150, 175, 200, 225**mm  
For use with 21/18 Omega Channel  
\*see Channels, Bolts and Fixings brochure for more information

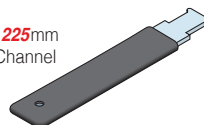

For recommended lengths, please refer to page 16 for frame cramps and page 18 for channel ties.

## References for Wall Ties

Many variations are available in addition to the standard ties. Wall ties for special applications may be specified and ordered with ease by using a reference letter for the tail, shank and head of the tie.

These bespoke ties are manufactured to order, typically for use on a single unique project and therefore are not tested to EN 845 and do not carry CE marking.

Ancon ties are produced in lengths from 150mm for masonry-to-masonry ties, and 75mm for masonry-to-concrete ties, in increments of 25mm. Drips will usually be positioned 90mm from the outer end of the tie (first reference letter). Masonry-to-masonry ties can also be supplied with a central drip. Special wall ties with a section wider than 20mm referenced S... will have an end with three holes without the side notches.

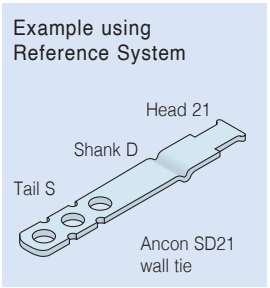

**TAIL**  
Most can be used at either end of tie

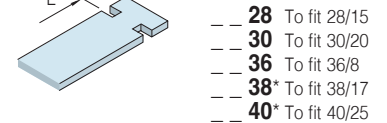
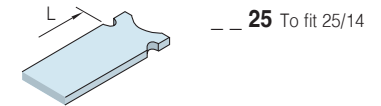
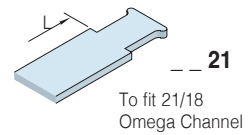
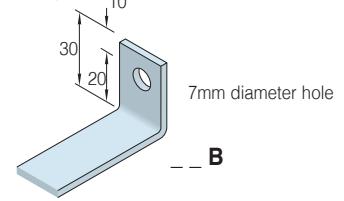
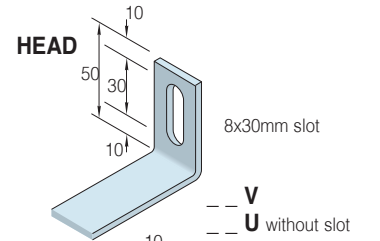
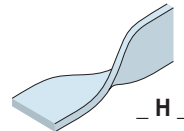
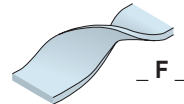
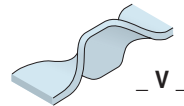
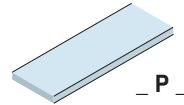
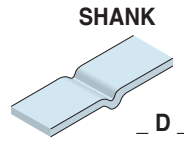
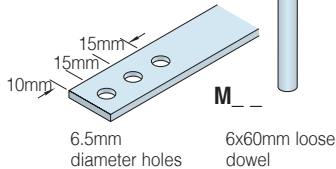
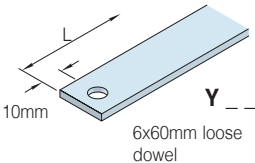
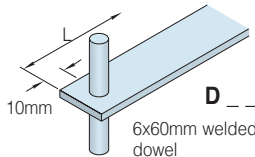
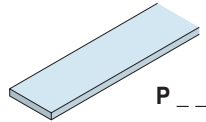
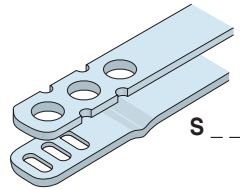
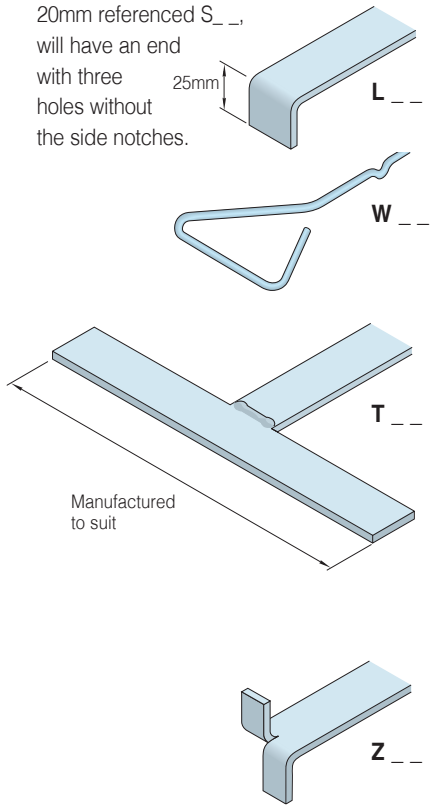

\*Tie will be 25mm wide

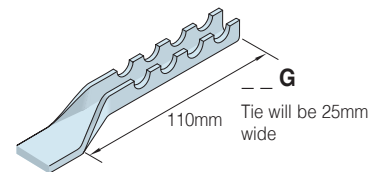
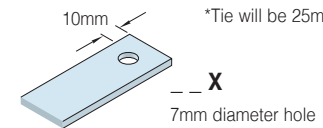

## Insulation Retaining Clips

The red Ancon Staifix Universal Insulation Retaining Clip (Eco Clip) will fit all the standard stainless steel ties shown on page 21. The black Teplo-Clip should be used with the Teplo range and the TJ2 wall tie (see page 14).

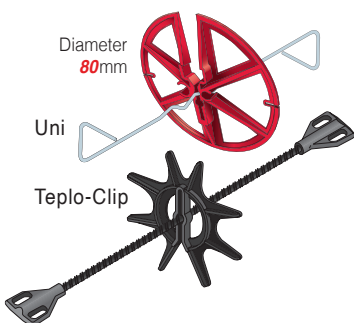

## Stainless Insulation Retainer

The DHM Stainless Insulation Retainer is for securing fire-resistant soft or pressure-resistant insulating materials to concrete, blockwork and brickwork. The DHM has Fire Resistance Classification R120 and guarantees a secure fixing of fire resistant insulation.

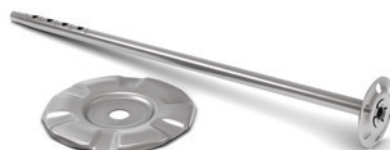

## Debonding Sleeves

Debonded Ties require 100mm embedment. A 120mm long sleeve will provide an allowance for movement and tolerance, and will be suitable for most applications. Other lengths and sizes available to special order.

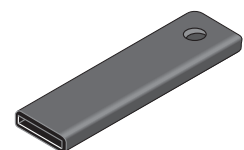

# Wall Ties and Restraint Fixings

## Non-Drill Fixings for Steelwork

The Ancon range of 'NON-DRILL' masonry-to-steel fixing solutions was developed to address the safety concerns of the Industry.

Driven by customer demand for masonry restraint fixings with an alternate installation method from either shot-firing or drilling, our company engineered the innovative solutions detailed here. These fixings do not require the use of power tools and can reduce installation times and costs. In all instances they simply about the column or attach to the flange to restrain the wall against lateral wind loads.

### Design Sheets

Contact us on +44 (0) 114 275 5224 or visit [www.ancon.co.uk](http://www.ancon.co.uk) for a Non-Drill Fixings Design Sheet. This sheet summarises all the information we require to specify/quote for the most appropriate non-drill fixing to suit your application.

### Ancon NON-DRILL fixings:

- Eliminate the dangers associated with shot-firing and drilling
- Quick, simple and economical to install
- No power tools required
- No special skills or equipment required
- Fixings either about the column or attach to the flange

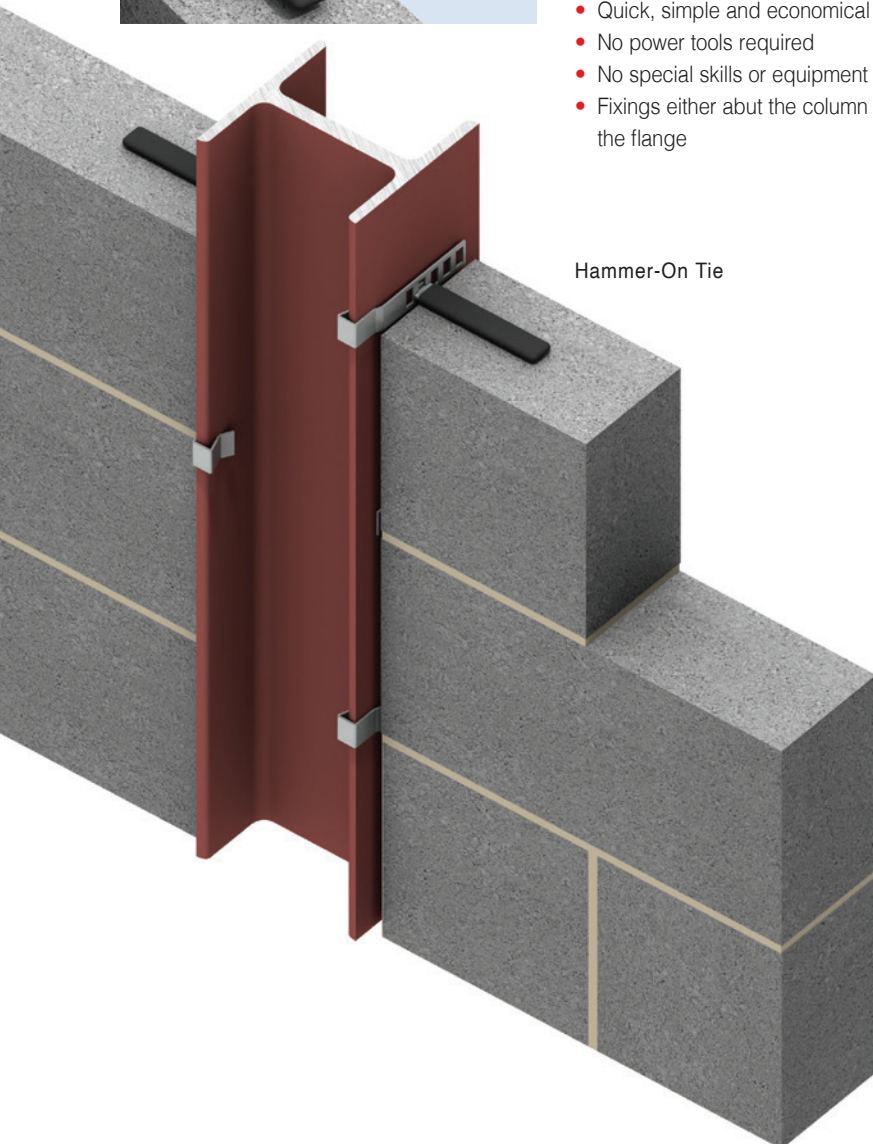
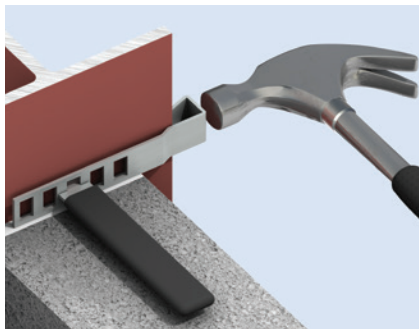

Hammer-On Tie

## Hammer-On Section

Available in five sizes to accommodate a steel thickness from 6.8mm to 25mm, this fixing is simply hammered onto the flange. It can be utilised either on a column with a tie (HOS-TIE) or on a beam with an internal head restraint (IHR-H).

Hammer-On Section Size	Flange Thickness Accommodated
XS	6.8-10mm
S	10-13mm
M	14-17mm
L	18-21mm
XL	22-25mm

The wall tie (HOS-TIE) or head restraint (IHR-H) should be positioned central to the masonry leaf when located in one of the five fixing slots. The Hammer-On section is available in three lengths. Hammer-On Ties should be installed at 225mm vertical centres and Hammer-On Head Restraints at 450mm horizontal centres. For more information on the IHR-H Head Restraint see page 24.

**The Hammer-On Section resists load in one direction only and should be installed on alternate sides of the flange.**

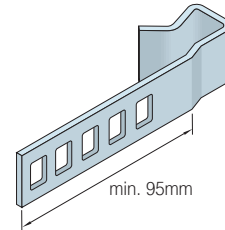

Hammer-On Section

Lengths 95mm, 155mm, 215mm

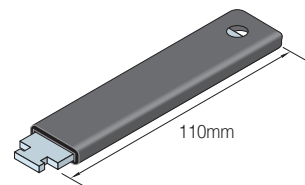

Hammer-On Tie (Debonded HOS-TIE, pictured above, supplied complete with Hammer-On Section)

Hammer-On Ties used at 225mm centres provide a design resistance of 1993N per metre.

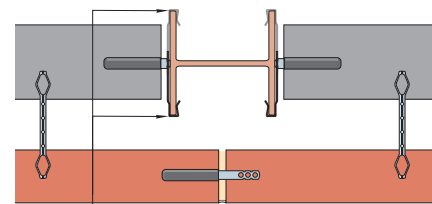

Hammer-On Ties installed to alternate sides of the column at 225mm vertical centres



### Internal Column Tie

Available in seven lengths, this tie fits between the flanges of a column. It should be installed at 225mm vertical centres, providing a design resistance of 6355N per metre.

Length (mm)	Beam/Column Accommodated
179	203 x 203 UC
186	203 x 133 UB
224	254 x 254 UC
232	254 x 146 UB
275	305 x 305 UC
281	305 x 127 & 165 UB
330	356 x 127 & 171 UB

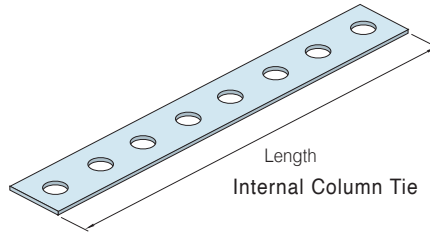

Length  
Internal Column Tie

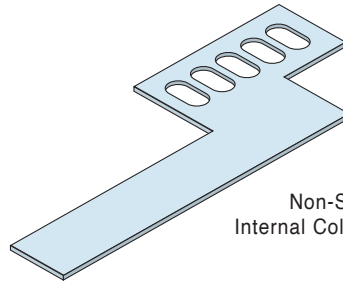
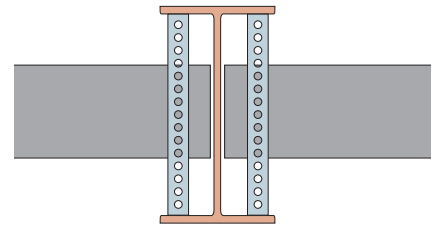

Non-Standard  
Internal Column Tie

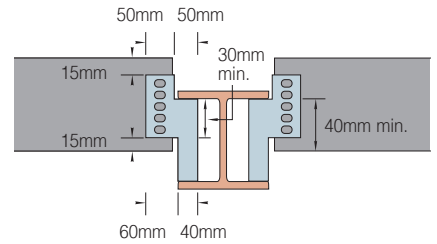

### Non-Standard Internal Column Tie

Special internal column ties can be designed to suit applications where the masonry does not sit inside the flanges of a column. The drawing provides some guidance on dimensions; contact us for more information.

### New Briclok

The Briclok fits to a column flange and can be used either across a cavity or back into the inner leaf. It should be positioned with the appropriate notch around the flange and installed at 225mm vertical centres. The tie must not be forced onto the column and should have no less than 10mm engagement. Two types (A and B) accommodate a steel thickness from 6.8mm to 20mm and are available in two lengths to suit an open cavity from 20mm to 80mm.

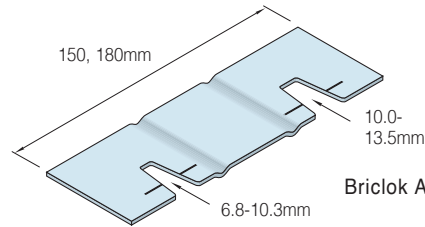

Briclok A

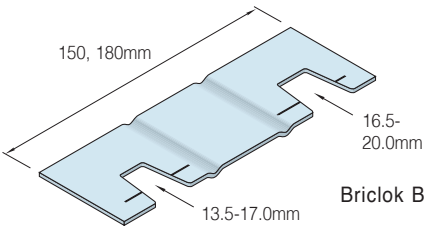

Briclok B

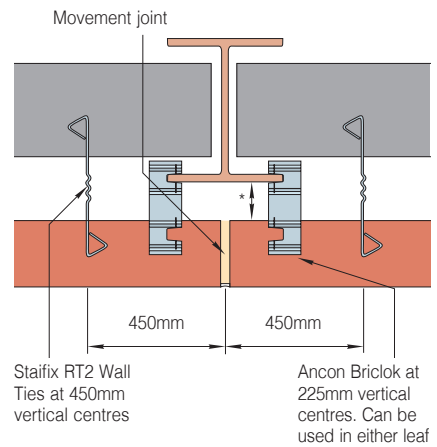

Briclok ties exceed the requirements for a Type 1 tie to PD 6697: 2019 in type M2 (iv) mortar.

### Column Tie

The Column Tie clamps to the flange of a column. It accommodates a steel thickness from 6mm to 25mm and should be installed at 225mm vertical centres. Manufactured in lengths to suit the application, it can feature a drip for use across the cavity or a plain shank for installation back into the inner leaf.

The clamp-on Column Tie is supplied right-handed as standard and can be manufactured left-handed on request.

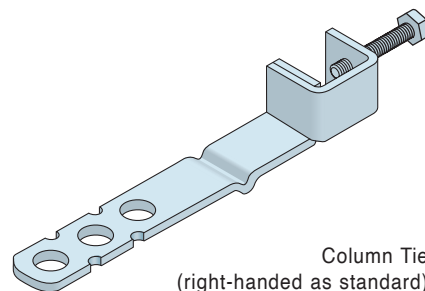

Column Tie  
(right-handed as standard)

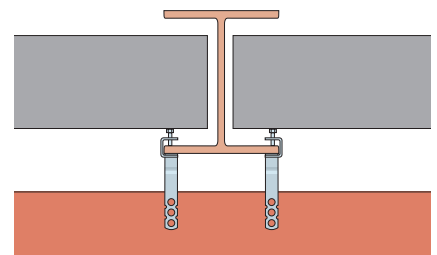

Product Code	Length	Open Cavity*	Flange Thickness
Briclok150A	150mm	20-50mm	6.8-13.5mm
Briclok180A	180mm	50-80mm	6.8-13.5mm
Briclok150B	150mm	20-50mm	13.5-20.0mm
Briclok180B	180mm	50-80mm	13.5-20.0mm

\* Open cavity at column face.

### Avoiding Bi-Metallic Corrosion

Bi-metallic corrosion may occur in a damp environment where stainless steel fixings are in contact with a structural steel frame. This will not affect the stainless steel but may cause slight surface corrosion to the mild steel. Best practice is to isolate the two dissimilar metals. Bitumen paint or some other form of isolation e.g. adhesive tape, applied at the point of contact will prevent this corrosion.

# Wall Ties and Restraint Fixings



Ancon IHR - B Bolted to Concrete, Restraining Top of Inner Block Wall



Ancon IHR-H Hammer-On Head Restraint

## Ancon Head Restraints

Ancon Head Restraints provide the necessary restraint to the top of masonry walls. They allow for vertical movement to accommodate shrinkage or thermal movement of the wall or structural frame, while restraining lateral loads.

Where head restraints are to be connected to a concrete frame, we will provide fixings suitable for cracked concrete.

### Ancon IHR - Internal Head Restraint

The Ancon IHR is designed to restrain the top of internal walls or the top of the inner leaf of a cavity wall. It comprises an L-shaped channel stem and a top section available in a variety of designs to suit different fixing methods and substrates; the top section slides in the channel to accommodate vertical movement between the blockwork and the structure.

An IHR comprises a sliding top section and a stem. The standard length of an IHR sliding top section will accommodate a gap of up to 50mm. Longer top sections are available to accommodate gaps of up to 75mm, ideal when a fire stop is being incorporated at the wall head or where greater deflection is expected in the floor.

The channel stem is closed at the front to prevent mortar ingress. The base of the stem should be built into the bed joint with the centre of the stem no closer than 50mm from the edge of the block. The vertical joint should be filled with mortar each side of the stem.

The standard height of an IHR will suit a 215mm block. Other stem lengths are available to suit cut blocks with a minimum height of 140mm.

The tables provide the design resistance per metre for the IHRs when installed with a 25mm, 50mm and 75mm gap, at 900mm and 450mm centres, in full and cut blocks.

The sliding tie can be provided with either a hole (IHR - B) or slot (IHR - V) to suit M8 bolts, with a notch end to fix directly into a 38/17 or 30/20 cast-in channel (IHR - C) and with a notch end to suit the Hammer-On Section (page 22) that attaches to a 6.8mm - 25mm steel flange without site drilling (IHR - H). It is also available to suit the SDTSS-38-5PT self-tapping screw (IHR-S).

### Example IHR Specification

(Delete/Amend as appropriate)

Ancon *IHR-B / IHR-V / IHR-S / IHR-H / IHR-C30 / IHR-C38* internal head restraint to suit a 215mm block and a 25-50 / 51-75mm gap.

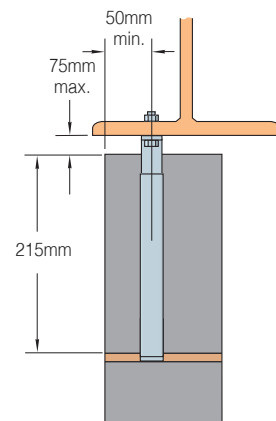

### Design Resistances - Full Block (215mm)

Product Reference	Spacing	Design Resistances		
		25mm Gap	50mm Gap	75mm Gap
IHR-B, IHR-V, IHR-C and IHR-S	900mm	1.78kN/m	1.22kN/m	1.06kN/m
	450mm	3.56kN/m	2.44kN/m	2.11kN/m
IHR-H	900mm	0.57kN/m	0.57kN/m	0.53kN/m
	450mm	1.13kN/m	1.13kN/m	1.06kN/m

### Design Resistances - Cut Blocks (min. 140mm)

Product Reference	Spacing	Design Resistances		
		25mm Gap	50mm Gap	75mm Gap
IHR-B, IHR-V, IHR-C and IHR-S	900mm	1.39kN/m	0.96kN/m	0.83kN/m
	450mm	2.79kN/m	1.92kN/m	1.66kN/m
IHR-H	900mm	0.44kN/m	0.44kN/m	0.42kN/m
	450mm	0.89kN/m	0.89kN/m	0.84kN/m

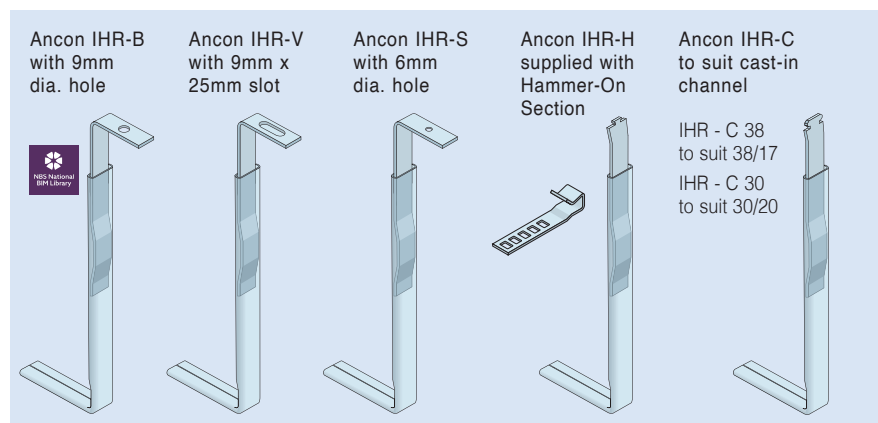

### Ancon FHR - Head Restraint

The Ancon FHR Head Restraint is used for restraining the top of internal walls or the internal leaf of a cavity wall. The two angles clamp the top of the wall and have 10mm diameter holes to suit M8 bolts. They are supplied with two holes in the longer angle to allow the restraint to fit 100mm and 140mm blockwork. Each restraint provides a design resistance of 1890N.

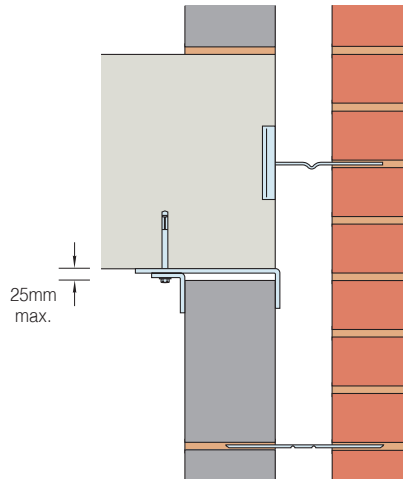
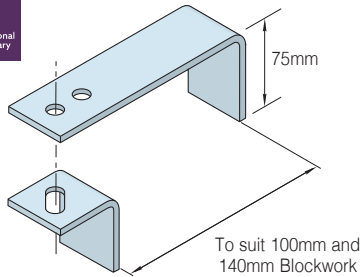

Ancon FHR Head Restraint Fixed to Underside of Floor Slab, Restraining Head of Inner Leaf of Cavity Wall

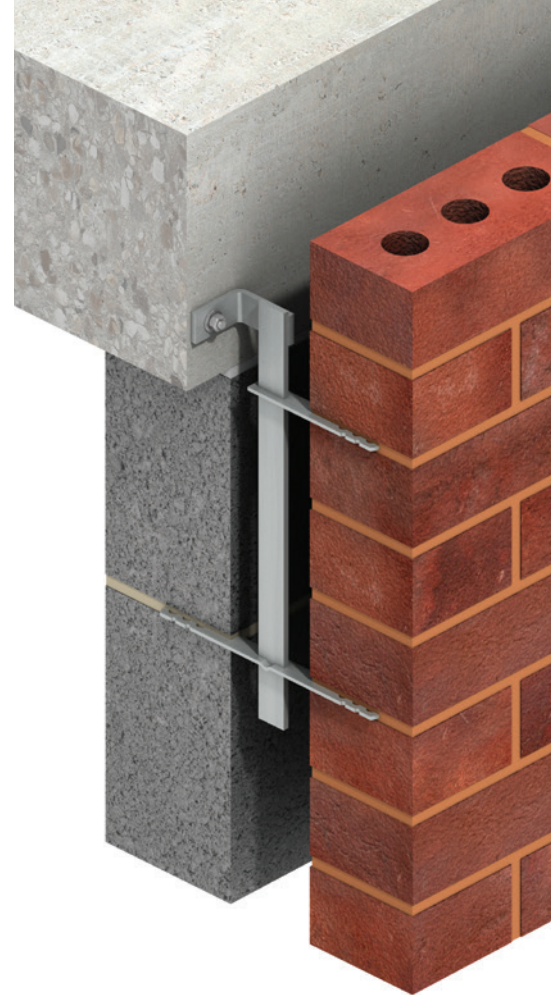

Ancon FHR Head Restraint - other sizes available

### Ancon SAH - Sliding Anchors

Ancon SAH Sliding Anchors have stems which fit within the cavity and accept ties that slide to accommodate vertical movement. Available with five different head options as standard, they can be supplied with one-way or two-way ties with safety ends.

The standard fixing hole is 12mm diameter to suit Ancon M10 Expansion Bolts (concrete), Ancon M10 Set Screws (steel) or M10 T-Head Bolts to fit Ancon 28/15 Channel. When fixing the Sliding Anchor to hollow steelwork (e.g. RHS), a non-standard Ø7mm hole is required in the head to suit an SDTSS-38-5PT self-drilling self-tapping screw. Ancon SAH Sliding Anchors have a design resistance of 755N per stem when the upper tie is within 75mm of the fixing. Ties should be spaced at a minimum of 150mm and at least two ties should be used per stem.

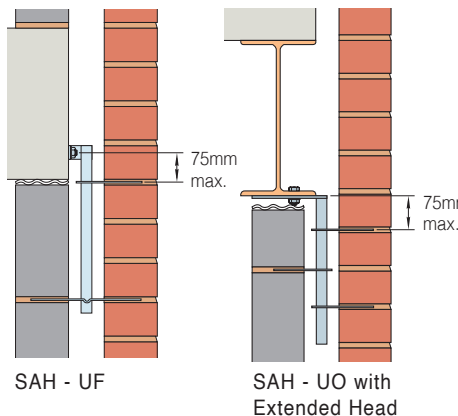

SIS  
Standard Lengths  
**200, 230**mm

Slot is positioned at the centre of the tie

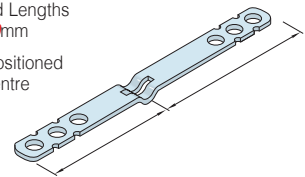

Other lengths and slot positions available to suit application

SPI  
Standard Lengths  
**135, 150**mm

Other lengths available to suit application

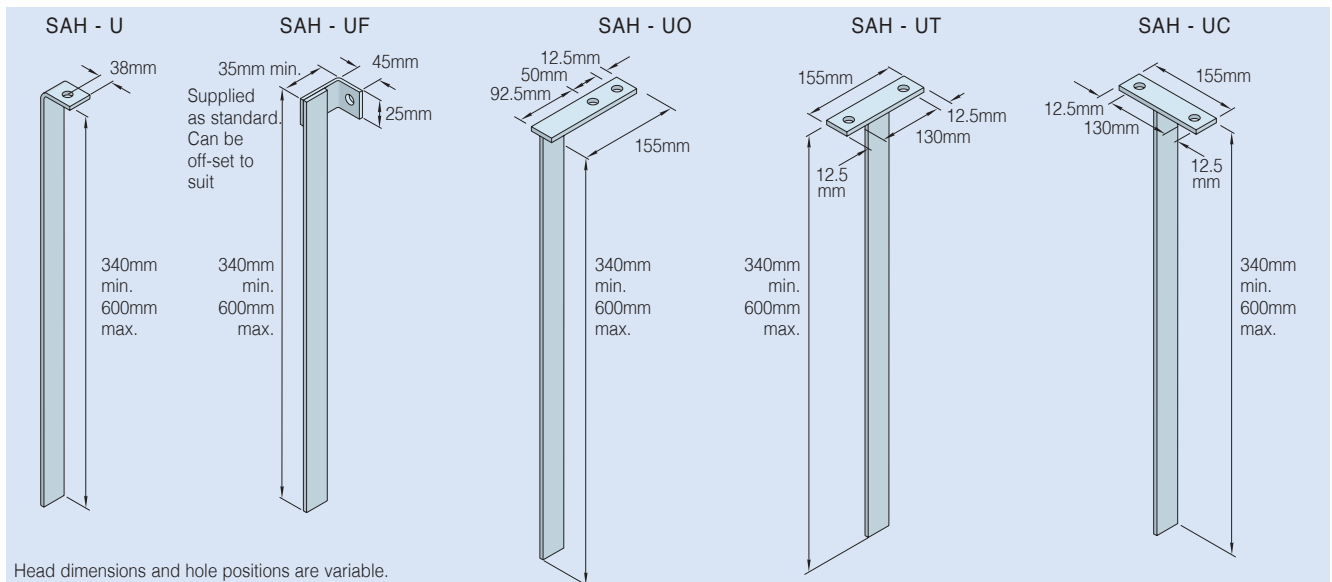
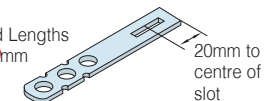

Head dimensions and hole positions are variable.

**Note:** These drawings are examples only. All sliding anchors are manufactured to suit individual requirements. Where sliding anchors are to be connected to a concrete frame, Ancon will provide fixings suitable for cracked concrete.

# Wall Ties and Restraint Fixings

## Acoustic Wall Ties

Ancon Acoustic Wall Ties feature a highly engineered, pre-compressed, acoustic isolation element. Products in this range provide the necessary structural performance, while minimising the transfer of airborne noise and vibration. Typical applications include: music rooms, recording studios, cinemas, nightclubs, industrial units, residential developments and mixed-use developments.

The acoustic performance of this range is far superior to other wall tie types and is the result of a carefully engineered balance between mechanical stiffness and high acoustic resilience. See table for comparisons.

## Dynamic Stiffness

Dynamic stiffness, as featured in Approved Document E of the Building Regulations, allows comparisons to be made between ties of different types and lengths. Research has shown that the dynamic stiffness of a wall tie featuring an acoustic isolator is determined by this element alone and is independent of the tie length and cavity width in which it is used (Robin Wilson, Heriot Watt University, 1992).

Approved Document E specifies the use of Type A ties in separating/party walls of new build residential developments in England and Wales. Type A ties must have a dynamic stiffness of less than 4.8 MN/m<sup>3</sup>. The dynamic stiffness of most Type 4 wire wall ties is only marginally below this threshold at a standard tie density of 2.5 ties/m<sup>2</sup>. In contrast, the Ancon Type 3 Acoustic Wall Tie range, with a comparable dynamic stiffness of just 2.15 MN/m<sup>3</sup>, offers a significant improvement over other Type A wall ties.

## Frequency

When considering sound insulation in buildings, the range of frequencies considered are generally between 50Hz and 5000Hz and these are normally banded into the low frequency range [50 – 200Hz], mid-frequency range [201 – 1000Hz] and high frequency range [1001 – 5000Hz].

Ancon Acoustic Wall Ties have been designed to fall within the lowest band.

## Structural Performance

All products in this range offer Type 3 wall tie performance to PD 6697: 2019 at a standard tie spacing of 2.5 ties/m<sup>2</sup> and are available in incremental lengths of 25mm to suit the cavity range stated. The table shows the calculated tie density to achieve other wall tie types and how this affects the dynamic stiffness (NM/m<sup>3</sup>). Contact us for more information. A CE declaration of performance is available online.



## Comparison of Acoustic Performance of Various Ancon Wall Tie Types

Wall Tie	PD 6697 Type	Cavity	Frequency*	Dynamic Stiffness**
ST1	1	50 mm	848 Hz	75.8 MN/m <sup>3</sup>
RT2	2	50 mm	500 Hz	25.5 MN/m <sup>3</sup>
HRT4	4	50 mm	208 Hz	4.7 MN/m <sup>3</sup>
<b>Acoustic Tie</b>	<b>3</b>	<b>-</b>	<b>139 Hz</b>	<b>2.15 MN/m<sup>3</sup></b>

\*Mean axial mass-spring-mass resonance frequency of the tie

\*\*At a standard tie density of 2.5 ties per sq.m. Test regime described in BRE information paper IP3/01.

## Ancon ACOU Acoustic Range Calculated Tie Density per Wall Tie Type

Equivalent Wall Tie Type	Tie Density (Spacing)	Dynamic Stiffness	Type A
<b>Type 4</b> Light Duty	<b>2.5 ties/m<sup>2</sup></b> (900mm x 450mm)	<b>2.15 MN/m<sup>3</sup></b>	✓
<b>Type 3</b> Basic	<b>2.5 ties/m<sup>2</sup></b> (900mm x 450mm)	<b>2.15 MN/m<sup>3</sup></b>	✓
<b>Type 2</b> General Purpose	<b>3.9 ties/m<sup>2</sup></b> (565mm x 450mm)	<b>3.35 MN/m<sup>3</sup></b>	✓
<b>Type 1*</b> Heavy Duty	<b>7.4 ties/m<sup>2</sup></b> (300mm x 450mm)	<b>6.36 MN/m<sup>3</sup></b>	-

For more information on wall tie types, refer to page 7. \* Type M2 (iv) mortar only

## Acoustic Cavity Wall Ties

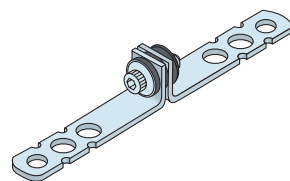

### ACOU SP-SP

Plain shank cavity tie  
Suits 50-175mm cavities  
Available with either a central or offset isolator

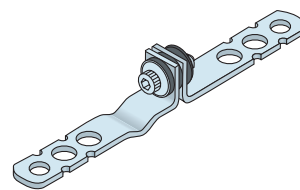

### ACOU SP-SD

Cavity tie with integral drip  
Suits 75-175mm cavities  
Available with either a central or offset isolator

## Acoustic Frame Cramps

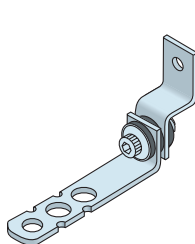

### ACOU SP-ZB

Plain shank frame cramp with 7mm fixing hole  
Suits 50-175mm cavities

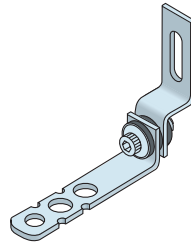

### ACOU SP-ZV

Plain shank frame cramp with 8mm x 30mm fixing slot  
Suits 50-175mm cavities

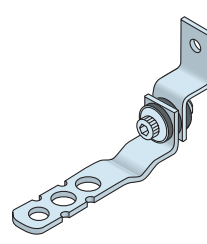

### ACOU SD-ZB

Frame cramp with integral drip and 7mm fixing hole  
Suits 100-175mm cavities

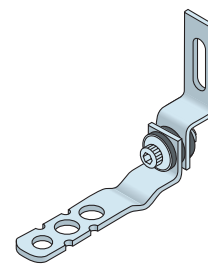

### ACOU SD-ZV

Frame cramp with integral drip and 8mm x 30mm fixing slot  
Suits 100-175mm cavities

Other variations are available. Please contact us with details of your application.

## Wall Starter Systems

### 36/8 Wall Extension System

The 36/8 Wall Extension System can be supplied with either SP36 ties or, where some longitudinal movement must be accommodated at the joint, PP36 ties complete with debonding sleeves. The channel can be supplied in lengths of up to 3.4 metres with each length having a series of holes to allow fixing to the existing wall. The system is available as a kit comprising ten ties, a length of 36/8 channel 2400mm long and ten plugs and screws for fixing at 300mm vertical centres. It is suitable for fixing to blockwork or concrete and has a design resistance of 1.6kN per metre.

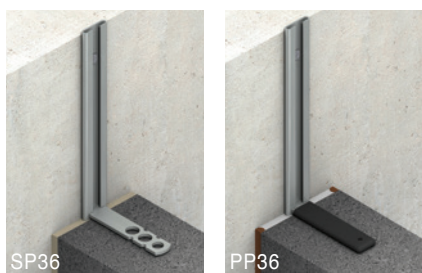

### Ancon Staifix Universal Wall Starter System

This system includes all necessary fixings to join a single skin of masonry, 2400mm high, to an existing brickwork or blockwork wall and is suitable for wall widths from 60mm to 250mm. Each pack includes 2 fixing strips, 5 plugs, 5 washers, 5 screws and 10 wall ties. Wall Ties slide within the fixing strip to course with the bed joints of any masonry unit. This Universal Wall Starter System has a design resistance of 1.7kN per metre and can be used in line with NHBC standards.



### Ancon Staifix Cavity Starter Tie

This tie simplifies the building of an inner leaf of blockwork within an existing structure. It is ideal for barn conversions.

The cavity starter tie is a Type 4 tie to PD 6697: 2019.

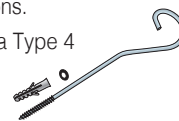

Length mm	Cavity mm	Embedment mm
180	50-70	65-85
200	75-95	65-85
230	100-120	65-85

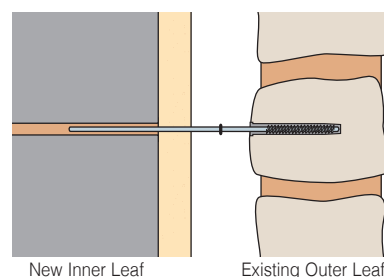

### Reveal Support Plate

The Ancon Reveal Support Plate is designed to support the first few bricks of a full brick (215mm deep) window reveal during construction. The plate will bond into the bed joint of the outer leaf providing a stable bearing for the reveal brick.

The long leg of the plate is built into the bed joint of the external leaf with the arrow pointing inwards. To ensure stability, the outer leaf should be built at least one brick high on top of the plate prior to the reveal brick being placed.

For other reveal depths please contact us.

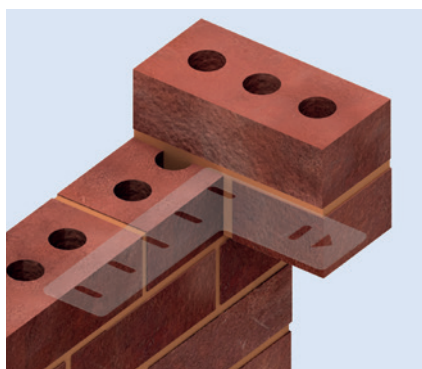
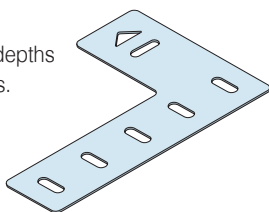

### Ancon Staifix Starter Tie

This tie is quick and simple to install. It is suitable for use in brickwork and blockwork of up to 3 storeys or 8 metres in height and can be used in line with NHBC standards.

Supplied complete with an 8mm nylon wall plug, the Starter Tie is fixed into the existing wall at an angle of 30° to the horizontal and bent into the bed joints of the new brickwork. Ties should be fixed at 225mm vertical centres and be central to each leaf of the new wall.

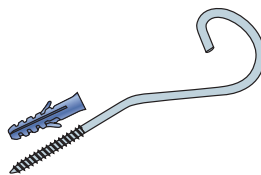

### Ancon Staifix Frame Tie

The Staifix Frame Tie is used to join timber door and window frames directly to brickwork. It is designed for use on buildings of up to 15 metres in height, and can be used in line with NHBC standards. The ties are screwed horizontally into the frame, surrounded by mortar and built into the bed joints of the new brickwork.

The vertical spacing of frame ties depends on the application. Please contact us or your local Staifix stockist for more information.

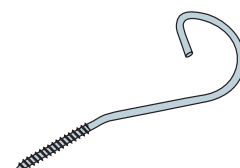

# Wall Ties and Restraint Fixings

## Restraints for Stone Cladding

Reference should be made to BS 8298-2: 2020 "Design and installation of natural stone cladding and lining", when selecting ties for restraining stone cladding. Restraints should be designed to resist wind loads and any imposed loads from, for example, window cleaning equipment.

Each stone will normally be restrained in four places, two at the top and two at the bottom. These are usually situated in the horizontal joints. The restraints should be located in pre-formed mortises or holes positioned in the centre of the thickness of the stone panel, and located at 1/4 points for half bonded stones and 1/5 points for stack bonded stones. Restraints should be kept at least 75mm from any corner with the peripheral distances between any two restraints not exceeding 1200mm.

The embedment of restraint dowels and lips into the stone should be at least 20mm. To achieve this, lipped ties (LPBs) have a 25mm downstand and dowelled ties (DPBs and YPBs) have 60mm long dowels.

The actual capacity of the restraints will normally be restricted by the breaking load of the stone and/or the restraint fixing bolt. Breaking loads at the fixing should be determined in accordance with BS EN 13364.

Frame cramps with a B end have a 7mm diameter hole to suit a range of fixings. Ancon M6 expansion bolts are recommended for fixing to concrete and M6 set screws or SDTSS-38-5PT self-drilling screws for fixing to steelwork. Frame cramps can be fixed to masonry with suitable plugs and screws or resin anchors. Poor substrates will limit the capacity of fixings and site testing is advisable in such applications. All fixings should be used in conjunction with a DIN washer.

## Coping Stones

For restraining horizontal coping stones, YPB ties may be used as pictured to provide nominal restraint. For copings on a slope e.g. gable ends, restraint fixings are designed to suit the requirements of the application, including the slope and size of stone. For applications involving abseiling loads or other loading arrangements, please contact our Technical Services team with details of your project for help with product selection.

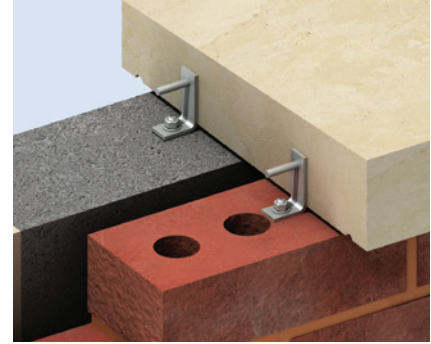

Two Ancon YPB Ties Restraining Coping Stone

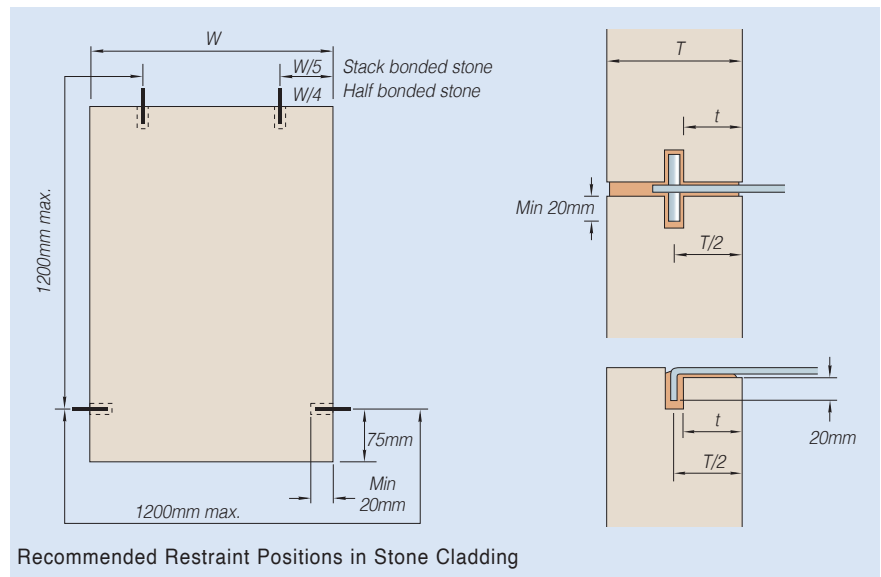

Recommended Restraint Positions in Stone Cladding

### Minimum Stone Thickness 'T' and Minimum Dimension Behind Restraint 't'

Type of Stone	More than 3.7m above ground - including facias		Soffits - including inlined soffits		Sills, copings and supported reveals	
	T (mm)	t (mm)	T (mm)	t (mm)	T (mm)	t (mm)
Granite, slate, white marble, quartzites	40	15	40	15	30	12
Hard limestone, travertines	40	15	40	15	30	12
Limestone, sandstone	75	30*	75	30*	50	302

\* t = T/2 if stone thickness (T) is greater than 75mm



Ancon YDB Ties Fixed to Blockwork



Buchanan Galleries, Glasgow

**Section of Ties**

Restraints for large stones and for use where cavities are in excess of 100mm may require special attention. They may need a much bigger section than standard 20 x 2.5mm; ties formed from 20 x 3mm, 25 x 3mm, 30 x 3mm and 30 x 4mm are frequently used for restraining stone cladding.

**Minimum Section of Dowels**

Stone Thickness	Minimum Diameter of Dowels
30mm and below	3mm
40mm	5mm
50mm and above	6mm

**Drip Position**

If a drip is required (e.g. YDB) please specify the position, indicating from which end of the tie the measurement is taken.

**Dowels**

Standard dowels are 6mm in diameter and 60mm long. These will be welded into the tail end of ties referenced D\_\_, and supplied loose with ties referenced Y\_\_ and the multi-holed M\_\_. 8mm and 10mm diameter dowels are also available upon request, as are longer lengths.

**Wire Ties**

The traditional method of fixing thin marble, particularly for internal linings and low rise cladding is with wire ties and plaster or mortar dabs. Wire ties are manufactured from 3mm and 5mm diameter wire.



Ancon LD21 Ties Fixed into 21/18 Omega Channel, Restraining Top of Stone

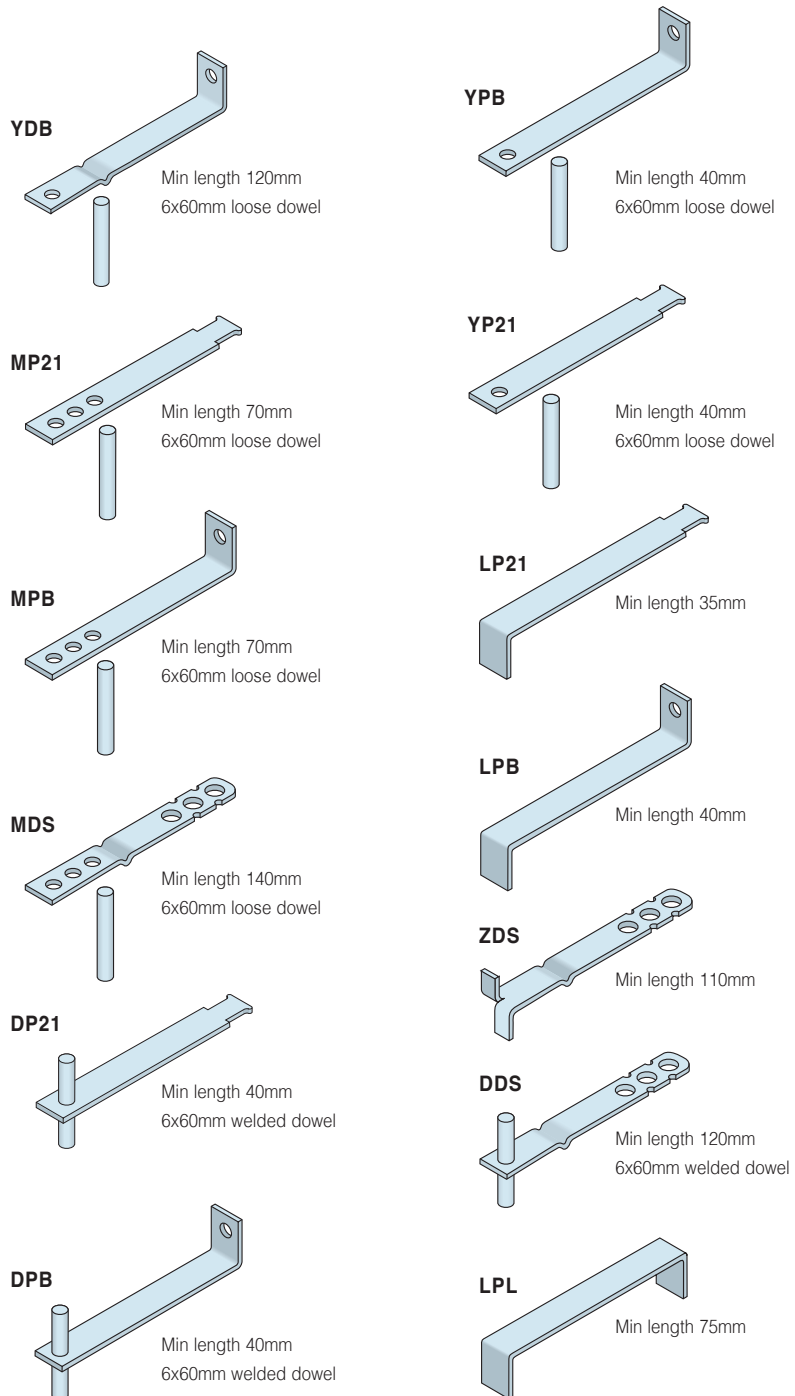
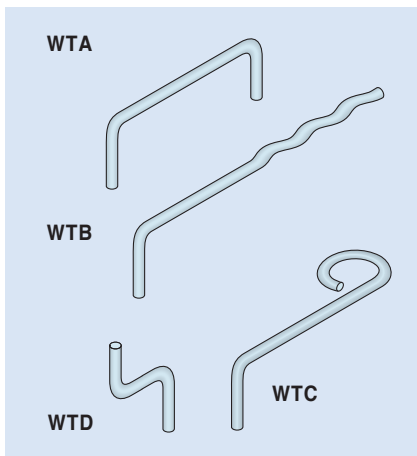

# Wall Ties and Restraint Fixings

## Ancon Push-Off Bolt

The Push-Off Bolt provides the centre of stone panels with additional resistance to the effects of impact loads, blast loads and positive wind pressure. The Bolt features a mechanical expander at one end which fixes securely into the inner leaf. The external stone panel is positioned with its inner face flush to the bolt's neoprene pad, which cushions the surface and prevents any rattling. The Push-Off Bolt is supplied in a variety of lengths to suit cavities from 100 to 200mm and can be fixed to both concrete and blockwork.

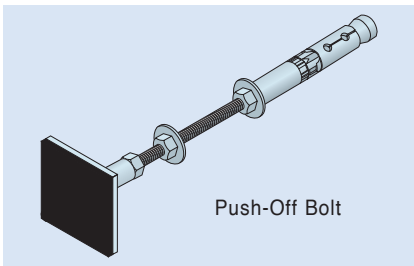

Museum of Scotland, Edinburgh

## Ancon 2000

Ancon 2000 restraint fixings are a simple and secure method of fixing thin facing slabs. Installation is quick and easy and can be verified using a setting torque or visual inspection. Vertical and lateral adjustment is provided by the slotted holes in the fixing clip. Resin-fixed options are available for fixing to masonry on request.

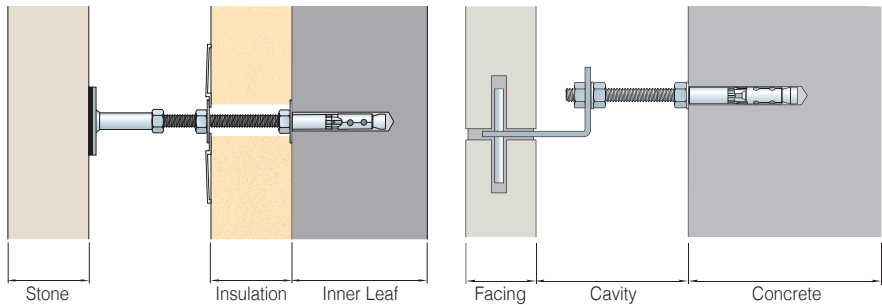
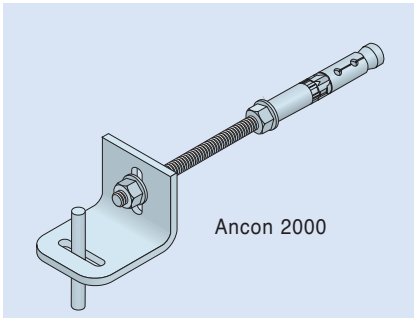

Ancon Push-Off Bolt

Ancon 2000

## Ancon 2000 Thin Facing Restraints

Reference	Facing Thickness (mm)	Cavity		Drill Hole Size (mm)	Setting Torque** (Nm)	Safe Working Load*** (N)
		Min.* (mm)	Max. (mm)			
2000/A	20	25	70	12 x 85	15	600
	25	22	67			
2000/B	30	30	75	12 x 85	15	600
	40	25	70			
2000 - 75	20	60	105	12 x 85	15	600
	25	57	102			
	30	55	100			
	40	50	95			

Other sizes are available to suit cavities up to 180mm - please contact Leviaat.

\*Studding will require cutting down on site to accommodate some cavity sizes.

\*\*Correct setting can also be confirmed by visual check - refer to installation instructions.

\*\*\*Based on C20/25 cracked concrete. For other substrates e.g. blockwork or steel, please refer to Leviaat's Technical team.



## Remedial Wall Ties

### Corrosion of Cavity Wall Ties

Wall ties are an essential element in the stability of masonry panels. Prior to 1978, wall ties were usually manufactured from galvanised mild steel. These ties were expected to last the lifetime of the building, but it has now been recognised that these wall ties can corrode after only 15 or 20 years.

When these ties corrode, they can expand to seven times their original thickness. This causes the brickwork to crack at the mortar joints and can result in major damage and sometimes the collapse of walls.

It is crucial that the problem is identified as quickly as possible and the correct remedial action undertaken.

### Testing and Tie Performance

The '63 range, Staifix R/R and Teplo-R have been independently tested in a variety of materials; a summary of the results is given in the tables. The failure loads noted are obtained from standard tests in brick couplets and provide indicative values of tie performance. The couplet test produces results of a conservative nature compared to actual wall tests. Due to the variability of materials, it is advisable to undertake a pull-out test on site to verify the selection of an appropriate tie. Ancon remedial wall ties do not carry product marking as the test regime in the European Standard EN 845-1 is inappropriate for remedial applications.

### Tie Spacing

Accepted practice is to follow PD 6697: 2019; that is maximum 900mm horizontally and 450mm vertically in a staggered pattern with 300mm vertical centres around openings within 225mm of the opening. Spacing should be determined by site testing of ties with a minimum density of 2.5 ties per m<sup>2</sup>.

### Fischer FIS VL 410 C Resin

This CE-marked, two part system of vinyl ester and hardener that we supply, is quick setting and suitable for a wide range of applications. An extension nozzle will be required when resin fixing remedial wall ties in the inner leaf of a cavity wall. Dispenser guns and additional static mixing nozzles are available.



### Installation of Remedial Wall Ties

Mechanical ties are easily installed by means of a Setting Tool which expands the brass ends in a drilled hole.

To install RM, Staifix Resin/Resin and Teplo-R remedial wall ties an extension nozzle and tube is required to pump resin across the cavity and into the inner leaf. The extension tube is supplied in a standard length of 1000mm and is cut to suit on site.

Installation guides are available to download from [www.ancon.co.uk](http://www.ancon.co.uk).



### Ancon RM 63 Range (Resin/Mechanical)

Drill (mm)	Drill Depth (Inner Leaf) (mm)	Tie Length (mm)	Nominal Cavity Width (mm)	Stock or Accrington Brick	Ultimate Tensile Load (kN)				
					Common Brickwork	Dense Concrete Blockwork	Light-weight Concrete Blockwork	40N Concrete	30N Concrete
11	70-75	200	35-60	3.3	3.0	2.6	2.1	3.2	2.9
11	70-75	225	61-85	3.3	3.0	2.6	2.1	3.2	2.9
11	70-75	250	86-110	3.3	3.0	2.6	2.1	3.2	2.9
11	70-75	300	135-160	3.3	3.0	2.6	2.1	3.2	2.9

**Note:** For cavities in the range 111mm to 134mm we recommend a Resin/Resin tie. Ties should not be positioned less than 10mm from the weather side of the outer leaf. Minimum embedment to the inner leaf is 70mm.

### Ancon MM 63 Range (Mechanical/Mechanical)

Drill (mm)	Drill Depth (Inner Leaf) (mm)	Tie Length (mm)	Nominal Cavity Width (mm)	Ultimate Tensile Load (kN)		
				Common Brickwork	Dense Concrete Blockwork	30N Concrete
12	55-65	200	45-70	6	3	8
12	55-65	225	70-95	6	3	8
12	55-65	250	100-125	6	3	8

### Failure Loads (Pull-Out) for Staifix R/R

Base Material	Compressive Strength (N/mm <sup>2</sup> )	Failure Load (kN)
Dense Concrete Block	7.0-10.5	5.78
Lightweight Concrete Block	2.8-3.5	2.87
Mortar Bed Joint, 1:1:6 Type (iii) PD 6697: 2019	-	5.37

### Ancon Teplo-R

Cavity Widths (mm)	Tie Lengths (mm)	Drill Diameter (mm)	Tie Diameter (mm)
75-450	215-590	10	7

**Note:** For applications outside those shown above, please contact us.

### Failure Loads (Pull-Out) for the Ancon Teplo-R

Base Material	Embedment (mm)	Ø7mm Tie Failure Load (kN)
Brick (20N/mm <sup>2</sup> )	70	4.73
Aerated Concrete Block (3.6N/mm <sup>2</sup> )	70	2.27
Foundation Concrete Block (7.3N/mm <sup>2</sup> )	70	2.29
Dense Concrete Block (C25/30)	70	11.90

**Note:** The failure loads given are pull-out tests only. The overall performance of the tie may be limited by other factors. For reduced embedment or alternative substrates, we recommend a site tensile test is conducted to ascertain actual performance. For further information please contact our Technical team to confirm suitability for specific applications.

# Wall Ties and Restraint Fixings

## Ancon 63 Mechanical/Mechanical

Used when tying together two leaves of solid materials, this tie has mechanical expanders at each end. Requires 12mm Ø holes.

## Ancon 63 Resin/Mechanical

For use when the material in the inner leaf is perforated, of low-density or a friable material. A resin fixing may be used to eliminate any imposed stress. Requires 11mm Ø holes.

## Ancon Staifix Resin/Resin

Used where mechanical expanders are unusable. Normally inserted into a 10mm Ø hole, but if test facilities are required, a 12mm Ø hole must be used. A plastic sieve can be used to retain resin and is particularly useful in perforated brick or hollow blockwork. A 12mm Ø hole is required to fit the sieve.

## Ancon Stairib Bar

Stainless steel ribbed bar, resin-grouted into the inner and outer leaves. Requires 10mm Ø hole (6mm dia. bar) or 12mm Ø hole (8mm dia. bar).

## Ancon AC 31

Used where bricks are removed then replaced in the outer leaf. The wavy end is resin-bonded into the inner leaf in a 10mm Ø hole.

The triangular end sits in the bed joint. Ancon AC 31 is supplied with a moveable neoprene o-ring that acts as a drip.

## Ancon AC 31C

Similar to the AC 31 but cranked by 25mm to aid fixing to the inner leaf. Requires 10mm Ø holes.

## Ancon Teplo-R

This plain-ended basalt fibre wall tie can be resin-fixed in remedial and retrofit applications. This tie has a thermal conductivity of only 0.7 W/mK. Requires Ø10mm hole (to suit Ø7mm bar).

## Ancon HRT4/R

Used for tying the two leaves of a cavity wall or separating wall where the first leaf has already been built. The wavy end is resin-bonded into the existing wall in a 10mm Ø hole. The tie is based on the Staifix HRT4 and has similar properties.

## Ancon Type A R/R

This is designed as a remedial tie for a separating wall. It will normally be inserted in 10mm Ø holes and resin-bonded into both leaves. It meets the requirements of a Type A wall tie to Approved Document E.

**Note:** For both the Ancon HRT4/R and Type A R/R, the presence and spacing of any existing ties needs to be carefully considered to ensure Type A is still achieved.

**Ancon MM 63**  
 200mm for 45-70mm cavities  
 225mm for 71-95mm cavities  
 255mm for 100-125mm cavities

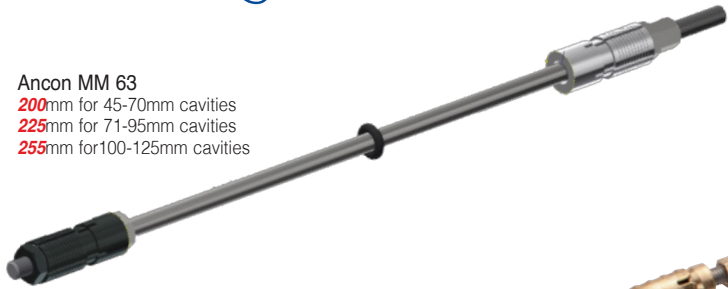

**Ancon RM 63**  
 200mm for 35-60mm cavities  
 225mm for 61-85mm cavities  
 250mm for 86-110mm cavities  
 300mm for 135-160mm cavities



**Ancon Staifix R/R**  
 180mm for 40-60mm cavities  
 200mm for 61-80mm cavities  
 220mm for 81-100mm cavities  
 240mm for 101-120mm cavities  
 260mm for 121-140mm cavities  
 280mm for 141-160mm cavities

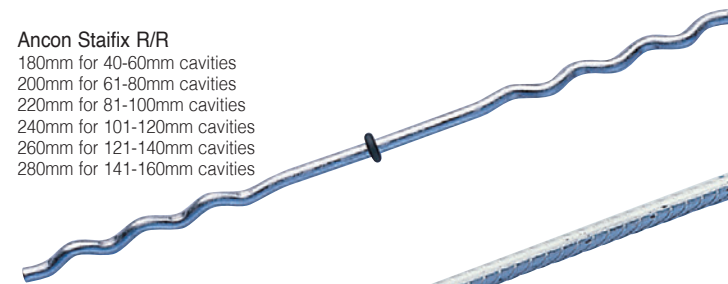

**Ancon Stairib Bar**  
 Length to order  
 6, 8mm dia.

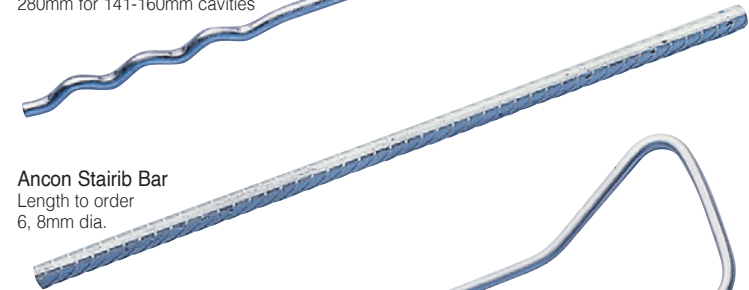

**Ancon AC 31**  
 Lengths 175, 200, 225,  
 250, 275, 300mm



**Ancon AC 31C**  
 Lengths 175, 200,  
 225mm



**Ancon Teplo-R**  
 Lengths 215-590mm

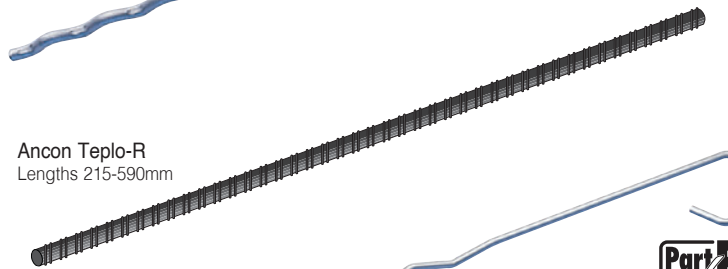

**Ancon HRT4/R**  
 Lengths 200, 225,  
 250mm

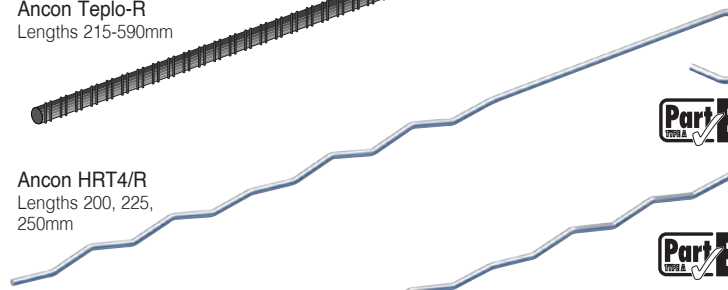

**Ancon Type A R/R**  
 Length 225mm



## Ancon Staifix-Thor Helical Crack Stitching Kit

The Staifix-Thor Helical Crack Stitching Kit is a high strength, non-disruptive solution for the permanent repair of cracked masonry. It is available from builders merchants and specialist distributors.

Ideal for either the remedial specialist or the contractor with a one-off repair job, the kit contains 10 Staifix-Thor Helical reinforcing bars (6mm x 1000mm), masonry repair grout (3 litres), a paddle for grout mixing, a grout applicator gun with a flat nozzle and a finger trowel.



Purchase of the kit, in preference to obtaining all the components individually, guarantees the correct specification and compatibility of reinforcement, grout and tools for this specific application. The kit is supplied in a single box with full installation instructions.



The stainless steel helical bars are chemically bonded into bed joints to stitch cracks, redistributing tensile forces and stabilising the structure. On completion, the bar and grout are concealed, retaining the original character of the wall.

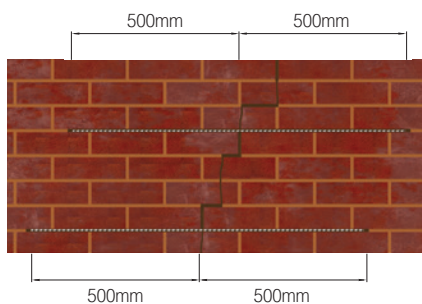

Please note it is essential that the cause of the cracking is established and eliminated prior to the installation of this system.

## Other Ancon Products

### Masonry Support Systems

Masonry cladding on concrete or steel frames is normally supported from stainless steel support systems. AnconOptima and Ancon MDC Systems create a continuous angle to support the outer leaf of masonry. Ancon Individual Brackets support masonry features such as curves and arches. A full design service is available to specifiers and users of Ancon systems.



### Masonry Reinforcement

Ancon AMR masonry reinforcement improves the structural performance of a wall by providing additional resistance to lateral loads. Located in the bed joint, it has a flattened profile to maintain good mortar cover even when lapped or used with wall ties. It is available in various standard configurations to suit a range of loading conditions and wall widths.



### Windposts and Parapet Posts

Large panels of masonry or panels with openings can often be difficult to justify structurally. Ancon Windposts are designed to provide additional lateral support for panels of brickwork. The range is manufactured from stainless steel and includes Windposts which can be installed into the inner leaf of blockwork and Windposts for installation into the cavity, which leave the blockwork undisturbed. Parapet Posts are used as vertical support for brickwork in either parapet or spandrel panels.



### Insulated Balcony Connections

Ancon thermally insulated connectors minimise heat loss at balcony locations while maintaining structural integrity. They provide a thermal break and, as a critical structural component, transfer moment, shear, tension and compression forces. Standard solutions are available for concrete-to-concrete, steel-to-concrete and steel-to-steel interfaces.



### Tension and Compression Systems

The use of tie bars in structures and buildings as an architectural as well as a structural element is increasing. Ancon Tension Systems comprise a range of components which can be supplied in carbon steel or stainless steel in a variety of sizes and finishes. The system looks particularly impressive when used with large areas of glazing or timber trusses.



For BIM objects of the above products visit [www.ancon.co.uk/BIM](http://www.ancon.co.uk/BIM) or [www.NationalBIMLibrary.com/Ancon](http://www.NationalBIMLibrary.com/Ancon)





**Leviat<sup>®</sup>**  
A CRH COMPANY

Innovative engineered products and construction solutions that allow the industry to build safer, stronger and faster.



## Worldwide contacts for Leviat:

### Australia

**Leviat**  
98 Kurrajong Avenue,  
Mount Druitt Sydney, NSW 2770  
Tel: +61 - 2 8808 3100  
Email: info.au@leviat.com

### Austria

**Leviat**  
Leonard-Bernstein-Str. 10  
Saturn Tower, 1220 Wien  
Tel: +43 - 1 - 259 6770  
Email: info.at@leviat.com

### Belgium

**Leviat**  
Industrielaan 2  
1740 Ternat  
Tel: +32 - 2 - 582 29 45  
Email: info.be@leviat.com

### China

**Leviat**  
Room 601 Tower D, Vantone Centre  
No. A6 Chao Yang Men Wai Street  
Chaoyang District  
Beijing · P.R. China 100020  
Tel: +86 - 10 5907 3200  
Email: info.cn@leviat.com

### Czech Republic

**Leviat**  
Business Center Šafránková  
Šafránková 1238/1  
155 00 Praha 5  
Tel: +420 - 311 - 690 060  
Email: info.cz@leviat.com

### Finland

**Leviat**  
Vädursgatan 5  
412 50 Göteborg / Sweden  
Tel: +358 (0)10 6338781  
Email: info.fi@leviat.com

### France

**Leviat**  
6, Rue de Cabanis  
FR 31240 L'Union  
Toulouse  
Tel: +33 - 5 - 34 25 54 82  
Email: info.fr@leviat.com

### Germany

**Leviat**  
Liebigstrasse 14  
40764 Langenfeld  
Tel: +49 - 2173 - 970 - 0  
Email: info.de@leviat.com

### India

**Leviat**  
309, 3rd Floor, Orion Business Park  
Ghodbunder Road, Kapurbawdi,  
Thane West, Thane,  
Maharashtra 400607  
Tel: +91 - 22 2589 2032  
Email: info.in@leviat.com

### Italy

**Leviat**  
Via F.lli Bronzetti 28  
24124 Bergamo  
Tel: +39 - 035 - 0760711  
Email: info.it@leviat.com

### Malaysia

**Leviat**  
28 Jalan Anggerik Mokara 31/59  
Kota Kemuning, 40460 Shah Alam  
Selangor  
Tel: +603 - 5122 4182  
Email: info.my@leviat.com

### Netherlands

**Leviat**  
Oostermaat 3  
7623 CS Borne  
Tel: +31 - 74 - 267 14 49  
Email: info.nl@leviat.com

### New Zealand

**Leviat**  
2/19 Nuttall Drive, Hillsborough,  
Christchurch 8022  
Tel: +64 - 3 376 5205  
Email: info.nz@leviat.com

### Norway

**Leviat**  
Vestre Svanholmen 5  
4313 Sandnes  
Tel: +47 - 51 82 34 00  
Email: info.no@leviat.com

### Philippines

**Leviat**  
2933 Regus, Joy Nostalg,  
ADB Avenue  
Ortigas Center  
Pasig City  
Tel: +63 - 2 7957 6381  
Email: info.ph@leviat.com

### Poland

**Leviat**  
Ul. Obornicka 287  
60-691 Poznan  
Tel: +48 - 61 - 622 14 14  
Email: info.pl@leviat.com

### Singapore

**Leviat**  
14 Benoi Crescent  
Singapore 629977  
Tel: +65 - 6266 6802  
Email: info.sg@leviat.com

### Spain

**Leviat**  
Polígono Industrial Santa Ana  
c/ Ignacio Zuloaga, 20  
28522 Rivas-Vaciamadrid  
Tel: +34 - 91 632 18 40  
Email: info.es@leviat.com

### Sweden

**Leviat**  
Vädursgatan 5  
412 50 Göteborg  
Tel: +46 - 31 - 98 58 00  
Email: info.se@leviat.com

### Switzerland

**Leviat**  
Grenzstrasse 24  
3250 Lyss  
Tel: +41 - 31 750 3030  
Email: info.ch@leviat.com

### United Kingdom

**Leviat**  
President Way, President Park,  
Sheffield, S4 7UR  
Tel: +44 - 114 275 5224  
Email: info.uk@leviat.com

### United States of America

**Leviat**  
6467 S Falkenburg Rd.  
Riverview, FL 33578  
Tel: (800) 423-9140  
Email: info.us@leviat.us

### For countries not listed

Email: info@leviat.com

**Leviat.com**

#### Notes regarding this catalogue

© Protected by copyright. The construction applications and details provided in this publication are indicative only. In every case, project working details should be entrusted to appropriately qualified and experienced persons. Whilst every care has been exercised in the preparation of this publication to ensure that any advice, recommendations or information is accurate, no liability or responsibility of any kind is accepted by Leviat for inaccuracies or printing errors. Technical and design changes are reserved. With a policy of continuous product development, Leviat reserves the right to modify product design and specification at any time.



For more information on these products, contact:

**Leviat**

President Way  
President Park  
Sheffield, S4 7UR  
United Kingdom

Tel: +44 (0) 114 275 5224

Fax: +44 (0) 114 276 8543

Email: [info.ancon.uk@leviat.com](mailto:info.ancon.uk@leviat.com)

For sales enquiries:

Email: [sales.ancon.uk@leviat.com](mailto:sales.ancon.uk@leviat.com)

For technical enquiries:

Email: [tech.ancon.uk@leviat.com](mailto:tech.ancon.uk@leviat.com)

[Ancon.co.uk](http://Ancon.co.uk)

[Leviat.com](http://Leviat.com)