

SafeSeal™



Access Cover B125 SafeSeal™

Ductile Iron Group 2 Medium Duty

Wrekin's range of medium duty BS EN 124:2015 B125 Group 2 access covers have been manufactured to combine high strength and a light weight design and include additional features such as a single labyrinth seal and safety enhancements.

WREKIN PRODUCTS' STOCK CODE	CLEAR OPENING (C Ømm)	BASE OPENING (F Ømm)	OVERALL FRAME (A Ømm)	FRAME DEPTH (E mm)
DMS1B2/45D/K	450	490	550	30
DMS1B2/25D/K	250	280	340	30
DMS1B2/45D	445	495	550	35
DMS1B2/45D/KSQR	450	490	550x550	40

Note - Wrekin recommend protection of ironwork during exposure to construction works traffic.

Available options:

- Locking
- Enhanced Anti-Slip Coating
- Alternative Badging
- Neoprene Seal
- Ventilation Holes





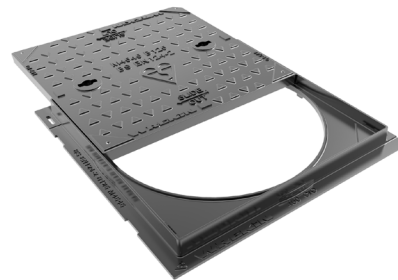



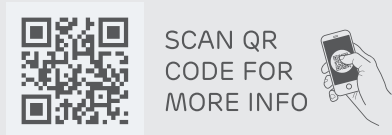

DMS1B2/25D/K



DMS1B2/45D/KSQR

1. Wrekin Products Ltd is continually seeking to improve our products and therefore reserves the right to alter product specifications without prior notice.
2. It is the responsibility of all users to satisfy themselves the above data is current.
3. Installation details are available on request.
4. Published January 2021 - Version 9.CT



-  For use in a Group 2 B125 class environment
-  Third party certified by BSI
-  Manufactured from strong and highly durable ductile iron
-  Labyrinth seal - Helps to prevent odour escape and water ingress
-  Safety keyway - Ensures key's secure in keyway when lifting
-  Exceeds BS EN 124:2015 requirements
-  Indexed covers ensure correct fitting
-  60+PSRV tested at top surface of chequer by UKAS accredited 3rd party

Dimensions:

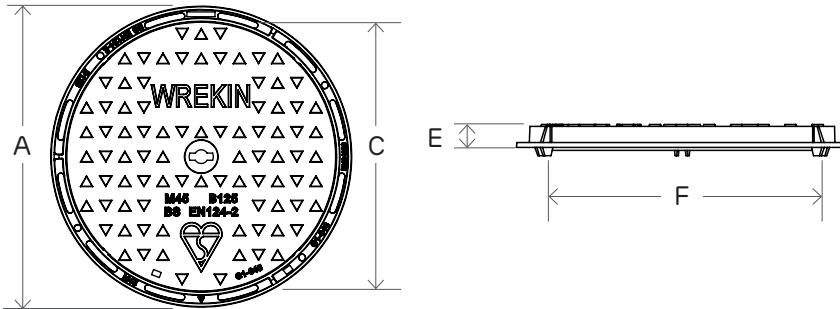

Diagram Key

A - Overall Frame Size	C - Clear Opening	E - Frame Height	F - Base Opening
------------------------	-------------------	------------------	------------------